

VersaSTUDIO

SIGN MAKER BN-20

MASTER GUIDE

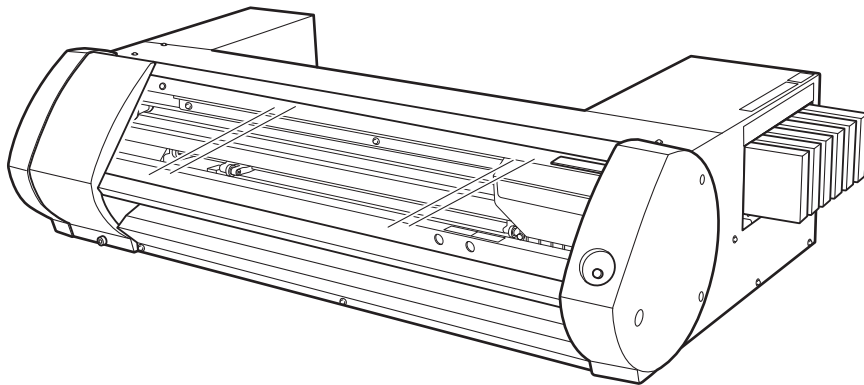

Thank you very much for purchasing this product.

- To ensure correct and safe usage with a full understanding of this product's performance, please be sure to read through this manual completely and store it in a safe location.
 - Unauthorized copying or transferral, in whole or in part, of this manual is prohibited.
 - The contents of this document and the specifications of this product are subject to change without notice.
 - The documentation and the product have been prepared and tested as much as possible. If you find any misprint or error, please inform us.
 - Roland DG Corp. assumes no responsibility for any direct or indirect loss or damage which may occur through use of this product, regardless of any failure to perform on the part of this product.
 - Roland DG Corp. assumes no responsibility for any direct or indirect loss or damage which may occur with respect to any article made using this product.
-

This product is using GNU General Public License (GPL) / GNU Lesser General Public License (LGPL) software. You have the right to acquire, modify, and distribute the source code for this GPL/LGPL software. You can obtain the GPL/LGPL source code used in this product by downloading it from the following website.

URL: <http://www.rolanddg.com/gpl/>

RolandDG Corp. has licensed the MMP technology from the TPL Group.

Contents

Contents	1
Chapter 1 The Basics	3
Introduction	4
Part Names.....	4
Roland BN-20 System Configuration.....	5
How to Open the BN-20 Driver's Printing Preferences Screen.....	6
How to Open the Utility Window / Exit the Utility.....	7
How to Start the R-Works	8
How to Open the BN-20 Driver/R-Works Help	8
Usable Media	10
Four Different Output Methods	11
Important Points During Use	11
Switching Power On and Off	12
Switching the Power On	12
Switching the Power Off (Sub-power Off)	13
Printing	14
STEP 1: Loading Media	14
STEP 2: Bidirectional Adjustment	19
STEP 3: Printing Tests and Normal Cleaning	21
STEP 4: Calibrate Sheet Feeding Amount	22
STEP 5: Starting Print Output	23
Stopping Print Output.....	24
Chapter 2 Fully Utilizing the Machine	27
Cutting / Printing & Cutting	28
Adjusting cutting.....	28
Accurately Adjusting the Cutting-in Amount	30
Adjusting printing & cutting	31
Creating Data for Cutting / Printing & Cutting.....	32
Cautionary note on making output with cutting	34
Performing Printing and Cutting Separately	35
To Perform Printing and Cutting Separately.....	35
Printing with Crop Marks.....	35
Aligning Automatically and Cutting.....	37
Crop Cut Adjustment	39
Using Metallic Silver Ink	40
Characteristics of Metallic Silver Ink and Important Notes	40
Creation of Print Data Using Metallic Color (R-Works).....	41
Creation of Print Data Using Metallic Color (General Application for Drawing).....	43
Blend Print and Layered Print	45
Blend Print (Metallic Silver + CMYK)	45
Layered Print (Metallic Silver ⇔ CMYK).....	50
Layered Print (CMYK ⇔ Metallic Silver)	55
Printing a Metallic Color Chart (R-Works)	60
Utility : Other Function.....	62
Performing Various Adjustments Through a Sequence of Operations.....	62
Setting of Dry Time	63
Resetting All Adjustments to Factory Default Values	66

Chapter 3 Maintenance	67
Introduction: About Maintenance	68
Automatic Maintenance Function: Points to Note	68
Maintenance Schedule	68
Checking Ink Levels and Replacing	69
Checking Ink Levels	69
How to Replace Ink Cartridges	70
Daily Maintenance	71
Maintenance of Ink Cartridges	71
Cleaning	71
Replacing the Waste Cartridge	72
Care and Maintenance of the Print Heads	73
Periodical Cleaning Maintenance	74
About Periodical Cleaning Menus	74
Medium and Powerful Cleaning	74
Manual Head Cleaning	76
Replacing Consumable Parts	78
Replacing the Wiper	78
Replacing the Felt Wiper	79
Replacing the Cutter Blade	80
When Moving the Unit	82
Procedures from Preparing to Move Through Reinstalling	82
Chapter 4 Appendix	83
Read this section whenever you face a problem	84
The Machine Doesn't Run	84
Attractive Printing or Cutting is Impossible	85
Media Jam Occurs!	87
Media Feed is Not Smooth	87
Print Head Stops Moving	88
Installation is impossible	89
When uninstalling the driver, perform following operation.	91
Important Notes When Performing Output from General Application	93
Important Notes When Performing Output from Adobe Illustrator	93
Important Notes When Performing Output from CorelDRAW	93
Handling Messages and Error Messages	94
A Message Appears	94
An Error Message Appears	95
Main Specifications	98
Maximum Area	98
Maximum Area When Using Crop Marks	98
About the Blade	99
Locations of the Power Rating and Serial Number Labels	99
Dimensional Drawing	100
Specifications	101
System Requirements for USB Connection	103

Chapter 1

The Basics

Introduction	4
Part Names.....	4
Roland BN-20 System Configuration.....	5
How to Open the BN-20 Driver's Printing Preferences Screen ...	6
How to Open the Utility Window / Exit the Utility	7
How to Start the R-Works.....	8
How to Open the BN-20 Driver/R-Works Help	8
Usable Media.....	10
Four Different Output Methods	11
Important Points During Use	11
Switching Power On and Off	12
Switching the Power On	12
Switching the Power Off (Sub-power Off).....	13
Printing.....	14
STEP 1: Loading Media.....	14
STEP 2: Bidirectional Adjustment.....	19
STEP 3: Printing Tests and Normal Cleaning	21
STEP 4: Calibrate Sheet Feeding Amount	22
STEP 5: Starting Print Output.....	23
Stopping Print Output	24

Introduction

Part Names

Maintenance cover

Remove when performing manual head cleaning.

☞ P. 76, "Manual Head Cleaning"

Print-head carriage

The print heads and blade are inside this section.

Front cover

Open the cover to load media; in general use, always keep the cover closed.

Pinch roller

When you move the loading lever to the front of the machine, the media is pinched. The right pinch roller is fixed in place.

POWER key

Cartridge slots

Location to install ink cartridges

Platen

This is the path over which the media passes. A print heater that helps fix the ink are built in.

Media clamps

These keep the media from coming loose and prevent fuzz on the cut edge of the media from touching the print head.

Grit rollers

These rollers feed out media toward the front of the machine.

Blade protector

This protects the tip of the blade during cutting.

Loading lever

You operate this when you load media.

Discharged fluid cartridge

Right media guide

Use this guide when loading media. The guide is on the "Right" when viewing the printer from the front.

Left media guide

Use this guide when loading media. This guide is on the "Left" when viewing the printer from the front.

USB connector

Main power switch

Power-cord connector

Roland BN-20 System Configuration

Necessary software for output

BN-20 driver
 Driver software that is needed to output printing data from a computer to the machine.
 ☞ P. 6, "How to Open the BN-20 Driver's Printing Preferences Screen," p. 8, "How to Open the BN-20 Driver/R-Works Help"

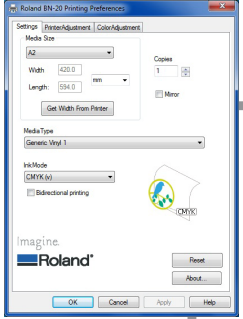

R-Works
 Software that allows you to draw illustrations or figures to be output by the machine.
 ☞ P. 8, "How to Start the R-Works," p. 8, "How to Open the BN-20 Driver/R-Works Help"

Commercially available application software



Roland VersaWorks
 This is a software RIP (Raster Image Processor). For more information, see "Roland VersaWorks Quick Start Guide" and "BN-20 VersaWorks Metallic Silver Ink Guide".



Necessary software to operate this machine



Utility
 This is the necessary software to operate this machine. The major functions are shown below:

- Display of messages and error messages
- Adjustment function
- Management of ink remaining amount
- Maintenance function

☞ P. 7, "How to Open the Utility Window / Exit the Utility"

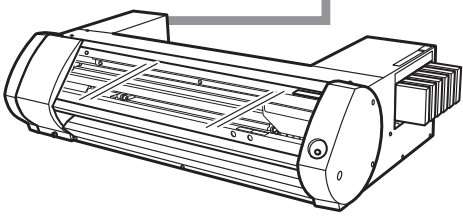

How to Open the BN-20 Driver's Printing Preferences Screen

Procedure

1

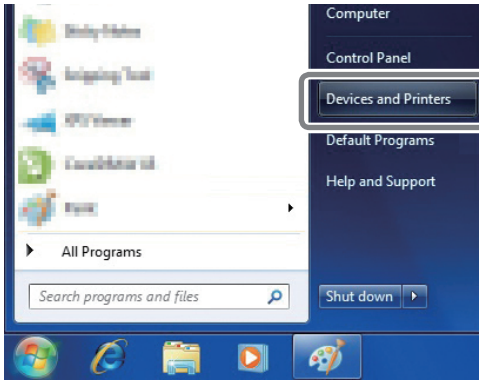

Click [Devices and Printers] (or [Printers and Faxes]) from the Start menu ().

2

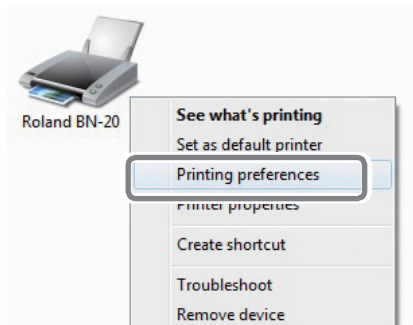

Right-click the "Roland BN-20" icon, and then click **Printing Preferences**.

The BN-20 driver's Printing Preferences screen opens.

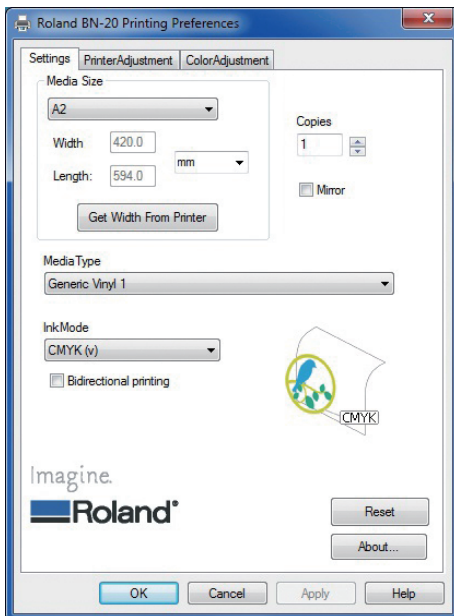

BN-20 Driver's Printing Preferences Screen

How to Open the Utility Window / Exit the Utility

How to Open the Utility Window

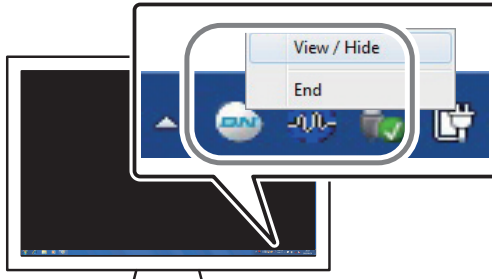

Click the  Utility icon on the task tray.
(Or, right-click the , and then click [View/Hide].)
The Utility window is displayed.

Utility is resident software

Utility is "resident software" that is always running. To hide the window, click  at the upper right of the window or click [Close]; Utility will not terminate.

If  is not displayed on the task tray, start Utility from the Windows start menu.

Starting from the Windows start menu

From the start menu, click [All Programs] or [Program] >> [Roland BN-20] >> [Utility].
Utility starts.

How to Exit the Utility

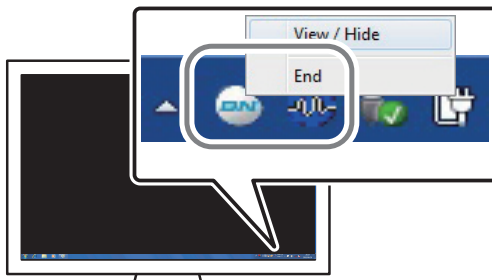

Right-click the  (Utility icon) in the task tray, and then click [End].
The Utility screen closes.

How to Start the R-Works

From the start menu (), click [All Programs] or [Program] >> [R-Works] >> [R-Works].

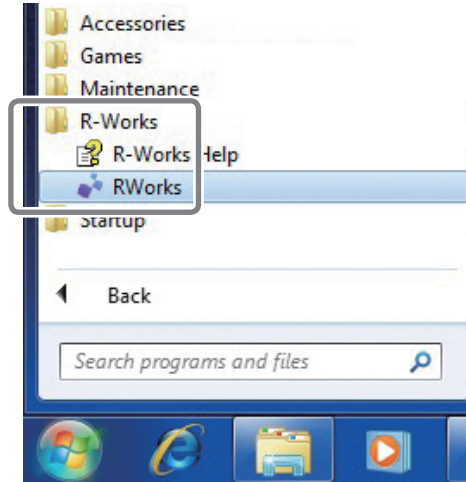

How to Open the BN-20 Driver/R-Works Help

BN-20 driver

Open the BN-20 driver's Printing Preferences screen, and then click [Help].

⇨ P. 6, "How to Open the BN-20 Driver's Printing Preferences Screen"

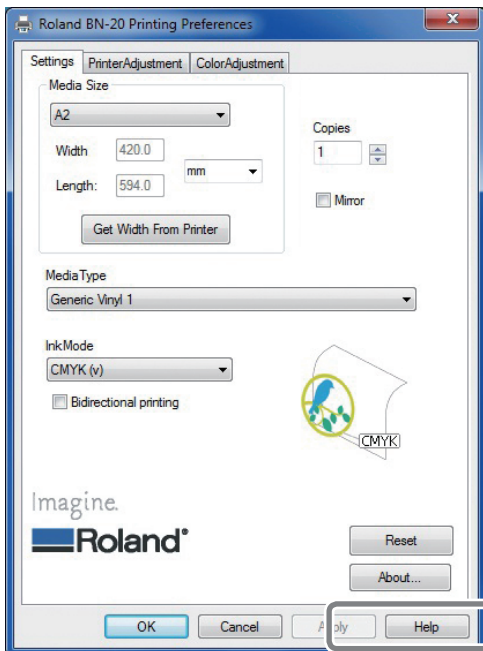

R-Works

Start R-Works, and then click [Help] - [Table of Contents] from the menu.

☞ P. 8, "How to Start the R-Works"

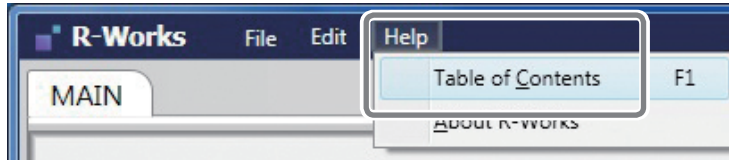

From the start menu , click [All Programs] or [Program] >> [R-Works] >> [R-Works Help].

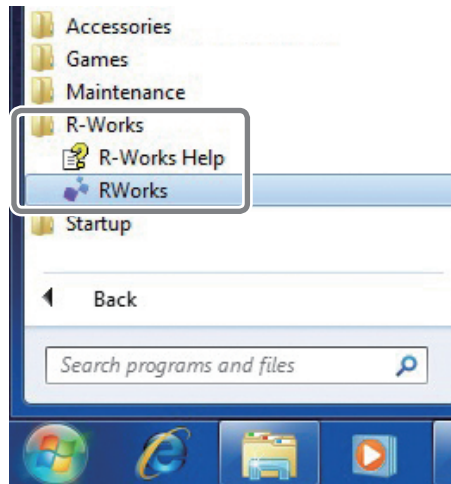

Usable Media

Some media are not suitable for use with this machine. When selecting media, always conduct a test and confirm the output quality meets your requirements.

Types of Media

This Master Guide uses the word “media” to mean sheets used for output. Media used with this machine are broadly classified into two types:

- Roll media: Media wound onto a paper tube
- Sheet media: Any media that is not wound on to a paper tube, e.g. standard size paper sheets

For both roll and sheet media, different types of paper can be selected according to the purpose. For details contact your media supplier. Media can also be purchased from the Roland DG Corp. website.
<http://www.rolanddg.com/>

Size

Width (For both roll media and sheet media)

- 150 to 170 mm (5.9 to 6.7 inch)
- 200 to 235 mm (7.9 to 9.3 inch)
- 287 to 322 mm (11.3 to 12.7 inch)
- 348 to 383 mm (13.7 to 15.1 inch)
- 393 to 429 mm (15.5 to 16.9 inch)
- 439 to 474 mm (17.3 to 18.7 inch)
- 487 to 515 mm (19.2 to 20.3 inch)

Cuttable media thickness (For both roll and sheet media)

0.22 mm (depending on the media composition)

Maximum media thickness including any backing paper or release paper (For both roll media and sheet media)

For printing only: 1.0 mm

For cutting: 0.4 mm

Roll outer diameter

150 mm

Paper tube (core) inner diameter

76.2 mm (3 in.) or 50.8 mm (2 in.)

Maximum roll weight

6 kg

Other conditions

The following media cannot be used.

- Roll media with inner start section glued to the paper tube (core)
- Heavily warped or curled media
- Media that cannot withstand the heat generated by the media heating system
- Media with a bent or crushed paper tube (core)
- Media that bends under its own weight when loaded
- Media with a bent roll
- Media that is rolled unevenly

Four Different Output Methods

The following four output methods are available for this machine.

Printing (Only)	Printing by using ink. It is also called "Printing Only" as well to distinguish from "Printing and Cutting."
Cutting (Only)	Cutting by using cutter such as for cutting seal. It is also called "Cutting Only" as well to distinguish from "Printing and Cutting."
Printing & Cutting	Printing method which performs printing followed by cutting. If sending output data which contains both printing and cutting information to the printer, cutting operation starts after printing finishes.
Crop Cut	Outputting method using "Crop Marks" to align printing and cutting result. In a case such as "removing the printed media and performing lamination, and then reloading it and performing cutting," align them using the crop marks and perform cutting.

Important Points During Use

Use the machine periodically

We recommend using the machine at least once a week. If left unused for a long period of time, the ink may settle, resulting in unstable discharge (and nozzle clogging). Any dry ink will need to be discharged.

About handling metallic silver ink

The usage and handling of metallic silver ink involve some important considerations that do not apply to ink of other colors.

Switching Power On and Off

WARNING

When output is not being carried out, remove media or switch the sub power off.

If the same section is continuously heated, there is a fire risk or media may generate toxic gas.

Switching the Power On

Procedure

① Close the front cover.

② Switch the main power on.

③ Press the **POWER** key.

When the POWER key indicator changes from flashing to steady, startup is completed.

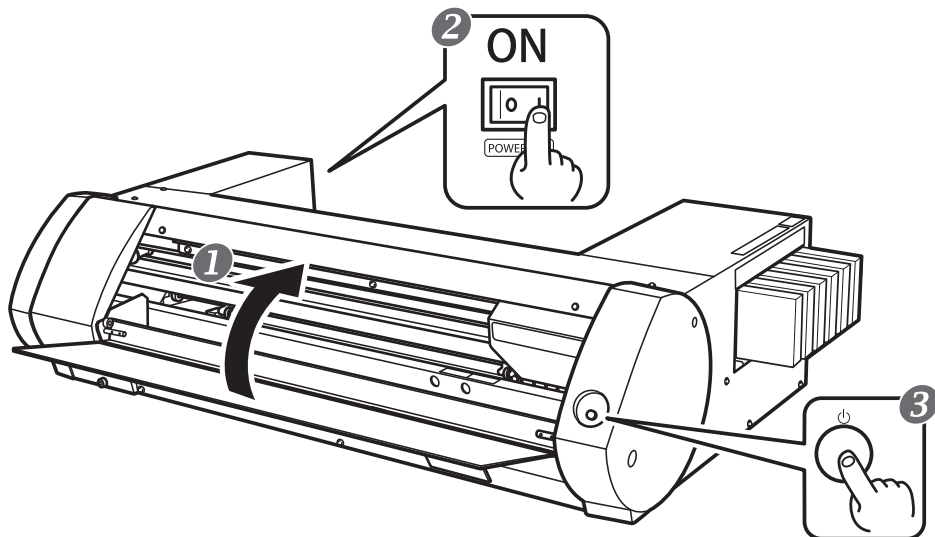

Switching the Power Off (Sub-power Off)

Procedure

- 1 When output is completed, press and hold down the POWER key for one second or more.**
When the POWER key light is off, the power is off.
- 2 Push the loading lever backward.**
Even if you are not going to switch the power off when the machine is not in use, make sure the loading lever is moved to the rear.

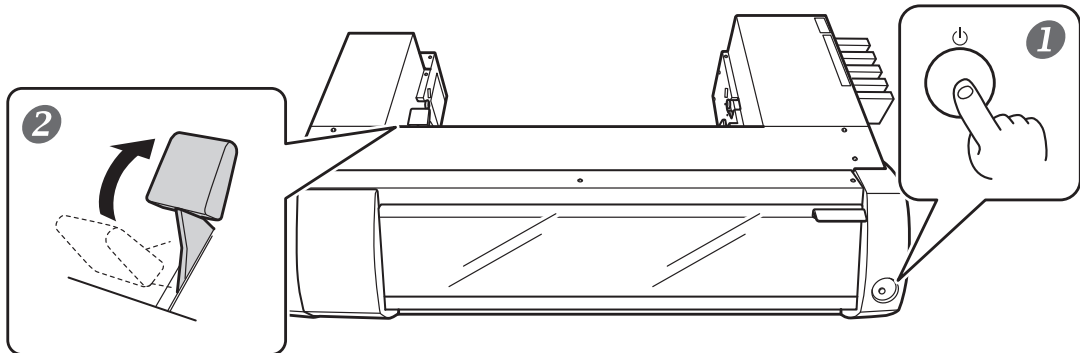

Make sure that the main power is on at all times

Never switch the main power off. Continuous power on allows the automatic maintenance function to work periodically. Failure to ensure automatic maintenance will result in a malfunction of the machine, such as a damaged print head.

During operation, never unplug or switch the main power off.

During operation, if the main power is switched off, or unplugged, the print heads may be damaged. The sub power switch must always be turned off before the main power is switched off. To turn off the sub power switch, press and hold down the POWER key. If accidentally the main power is switched off, immediately switch the main power and sub power (POWER key) back on again.

About Sleep Mode (Power-Saving Mode)

The machine has a power-saving function; after about 30 minutes of non-use the machine automatically changes to the lower power consumption sleep mode. In the sleep mode, the POWER key slowly flashes on and off. When you next operate the POWER key or send print data from a computer to the machine with media loaded, the machine returns to the regular mode.

Printing

This section describes operations when printing only. Refer to page 28 "Cutting / Printing & Cutting" and page 35 "Performing Printing and Cutting Separately."

STEP 1: Loading Media

Roll media

Procedure

- 1 **Push the loading lever backward.**
- 2 **Move the left media guide to the left.**

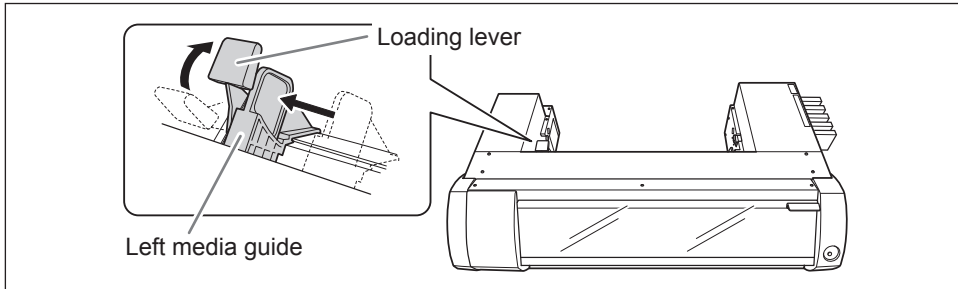

2

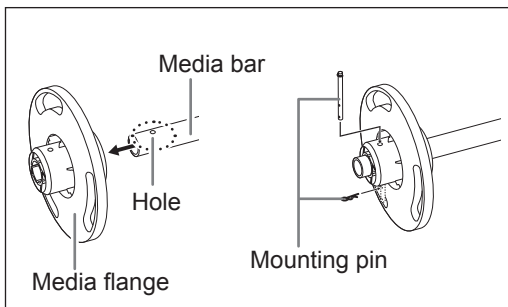

Attach the media flange to one end of the media bar.

Insert the side of the media bar with a hole into the media flange, and secure it with the mounting pin. Use one of the two media flanges. The inside should be the one that fits the inner diameter of the roll media paper tube.

- 3 **Load the roll media onto the media bar.**

Press the media flanges into the paper tube at both ends. Place the fixed media flange at the bottom, so that the media feeds in a clockwise direction when looking from above. You cannot set the media correctly if the feed direction is not correct.

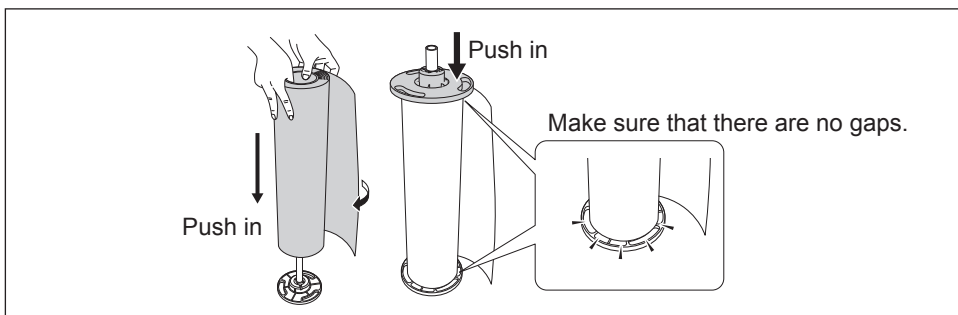

4 Place the roll media loaded onto the media bar on the printer.

Press both ends of the media bar into the grooves at the back of the printer while making sure the media does not become loose.

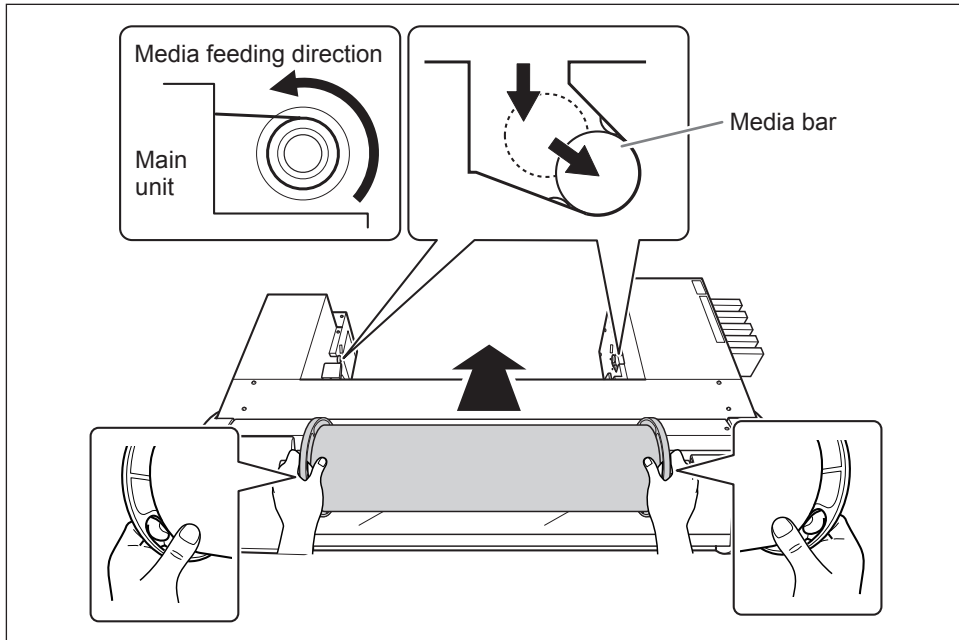

5 ① Move the roll media to the right so the media flange touches the right media guide.

② Slide the left media guide and press it to the media flange.

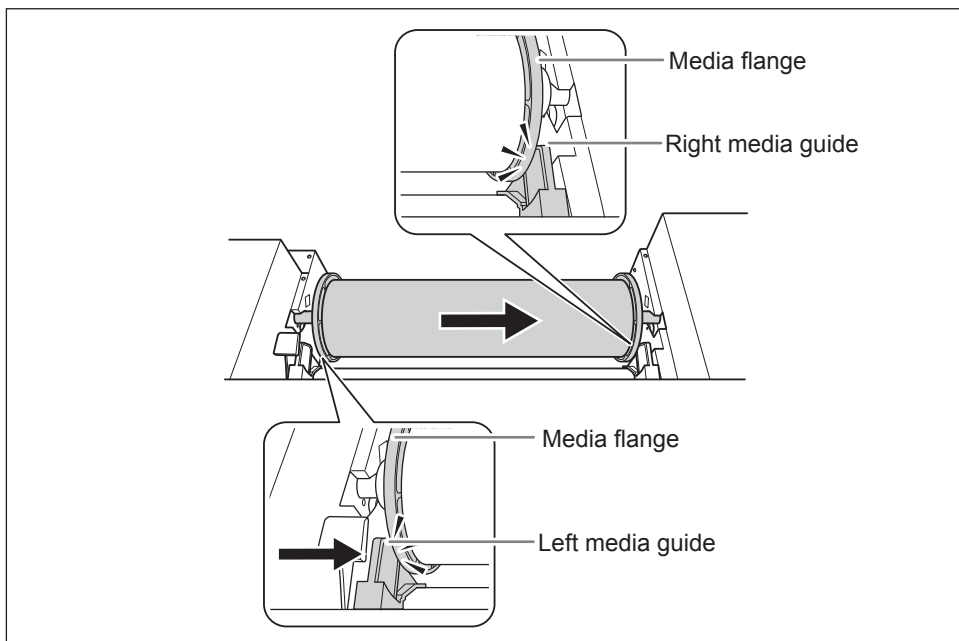

6 Pass the media through the printer.

Pull the media straight to keep it taut, and let it pass beneath the media clamps.

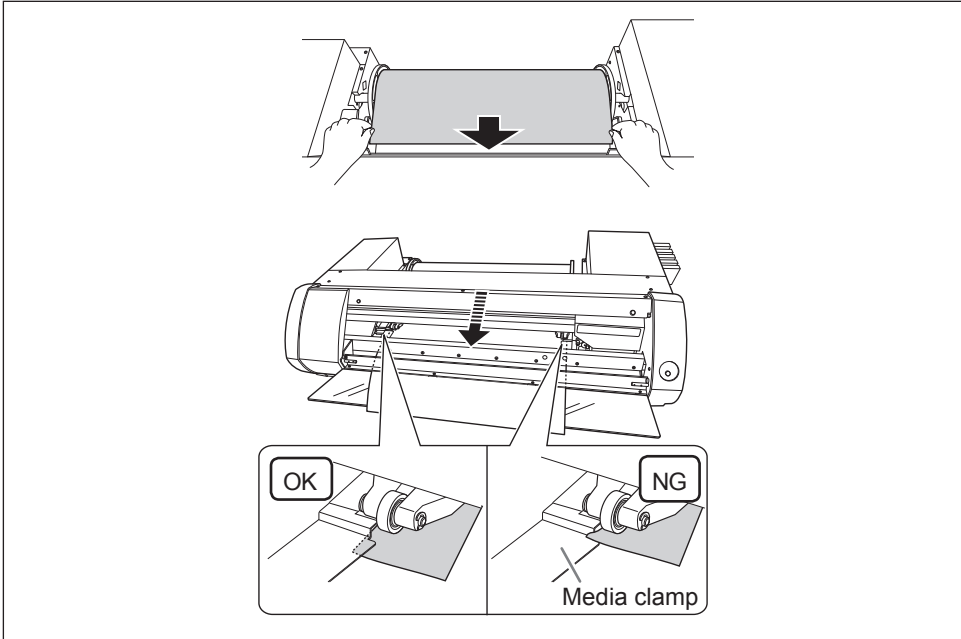

- 7**
- ① Make sure the left media guide is pressed against the media flange.
 - ② Close the front cover.
 - ③ Pull the loading lever forward.

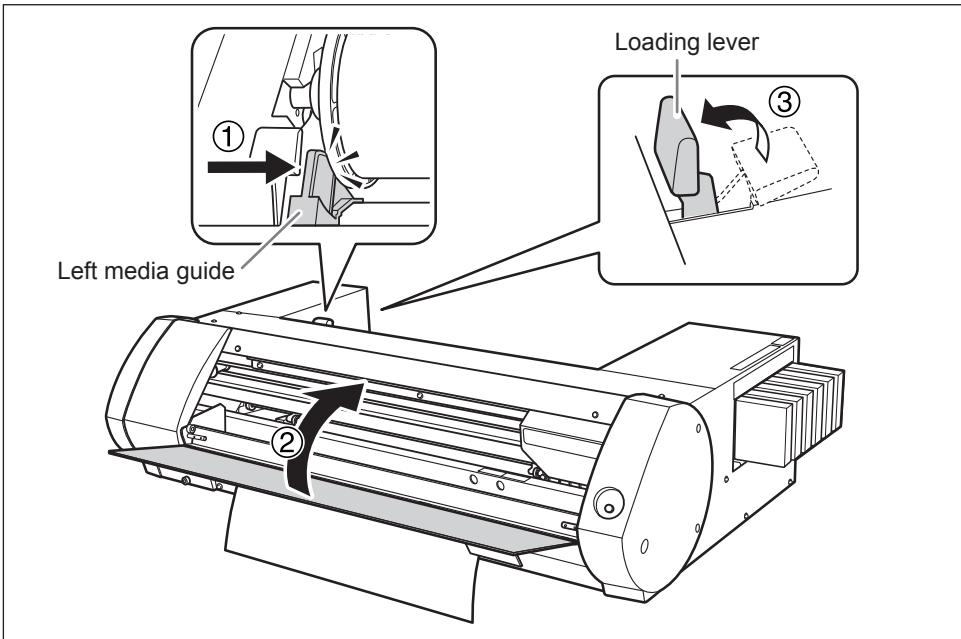

Sheet Media

Procedure

- 1**
 - ① Push the loading lever backward.
 - ② Move the left media guide to the left.

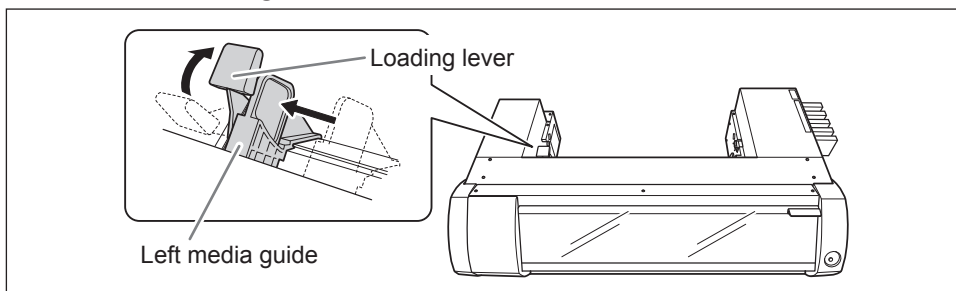

- 2**
 - ① Move the media to the right, and apply it to the right media guide.
 - ② Slide the left media guide and apply it to the media.

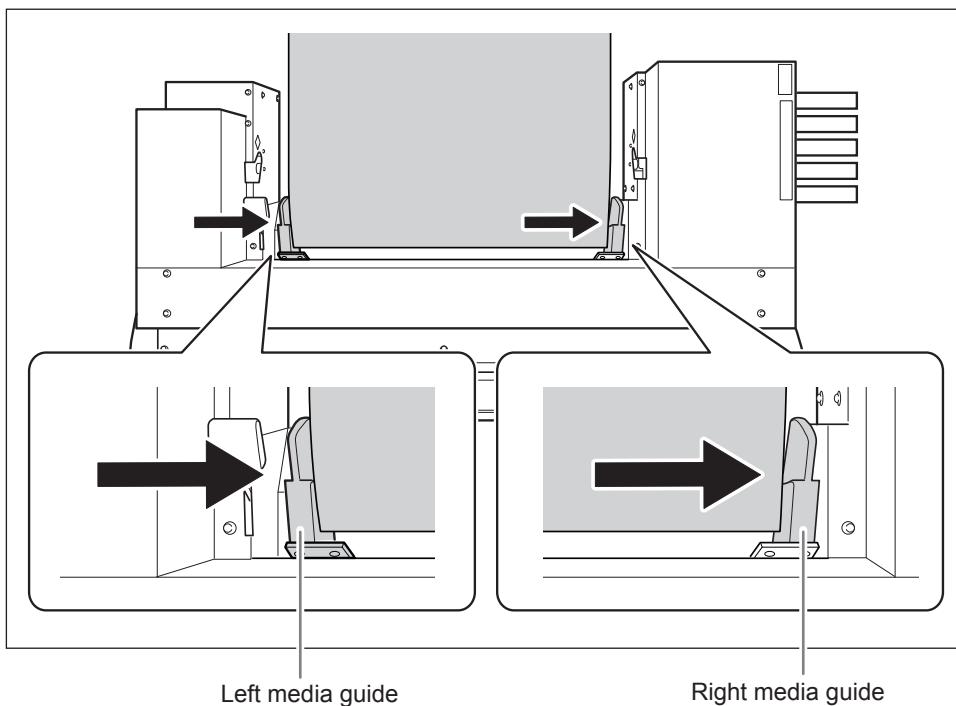

3 Pass the media through the printer.

Pull the media straight to keep it taut, and let it pass beneath the media clamps.

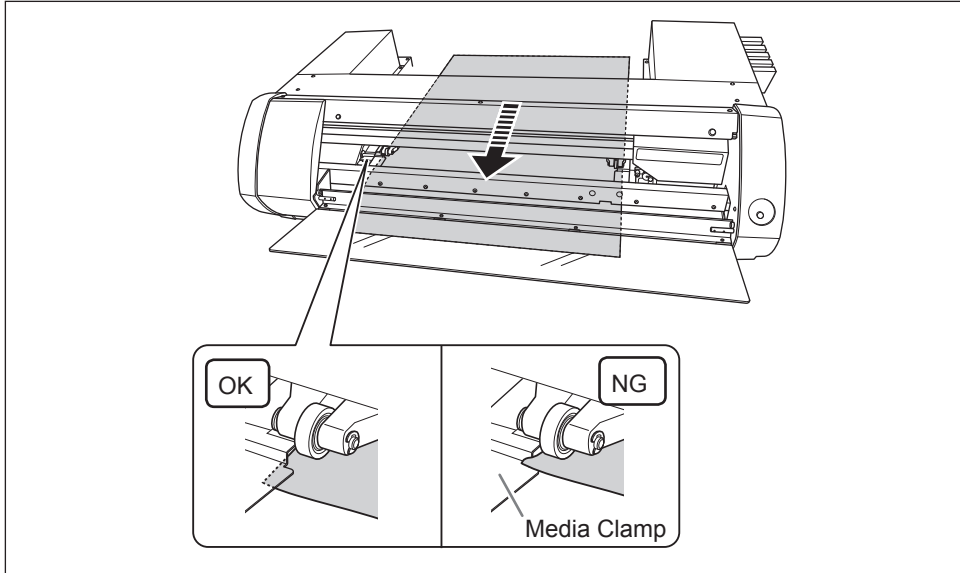

- 4**
- ① Make sure the left media guide is applied to the media.
 - ② Close the front cover.
 - ③ Pull the loading lever forward.

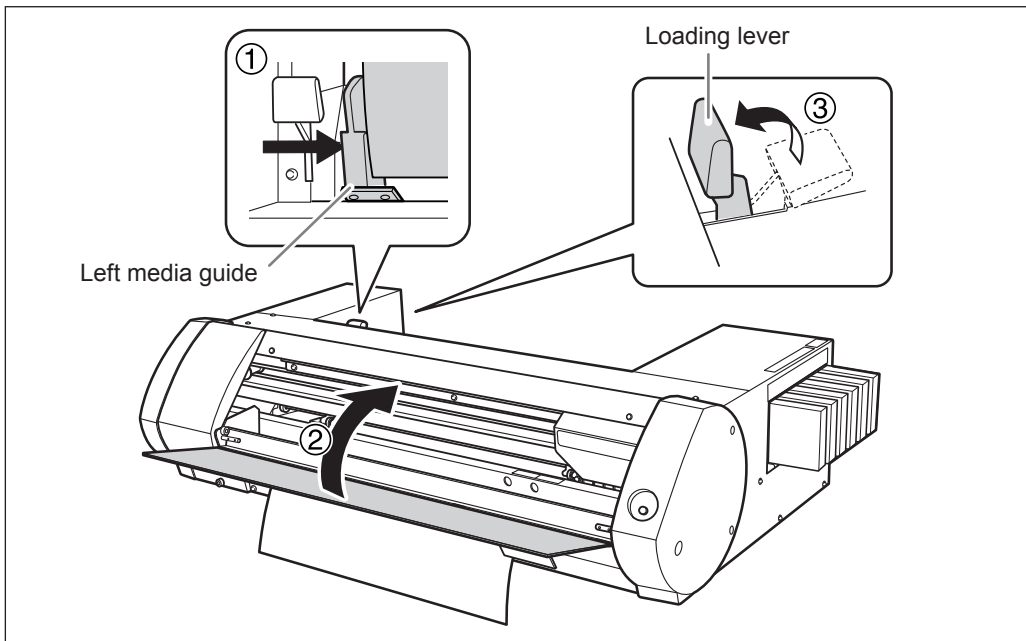

STEP 2: Bidirectional Adjustment

Perform adjustment in the following situations. You do not need to perform adjustment in other situations. Go to page 21 "STEP 3: Printing Tests and Normal Cleaning."

- When using this machine for the first time
- When changing the media to use for the first time

What are bidirectional printing and bidirectional adjustment?

When printing with four colors, Cyan (C), Magenta (M), Yellow (Y), and Black (K), this machine can perform "Bidirectional Printing" which means that the head prints when moving in both directions. Bidirectional printing offers the advantage of being able to shorten output times, but subtle misalignment occurs during the out-bound and return passes. The operation to correct these misalignments is called "Bidirectional Adjustment".

How to Perform Bidirectional Printing

Procedure

- 1** Display the BN-20 driver's Printing Preferences screen.
☞ P. 6, "How to Open the BN-20 Driver's Printing Preferences Screen"
- 2** Select [CMYK(v)] from [Ink Mode] on the [Settings] tab.
- 3** Select [Bidirectional Printing].

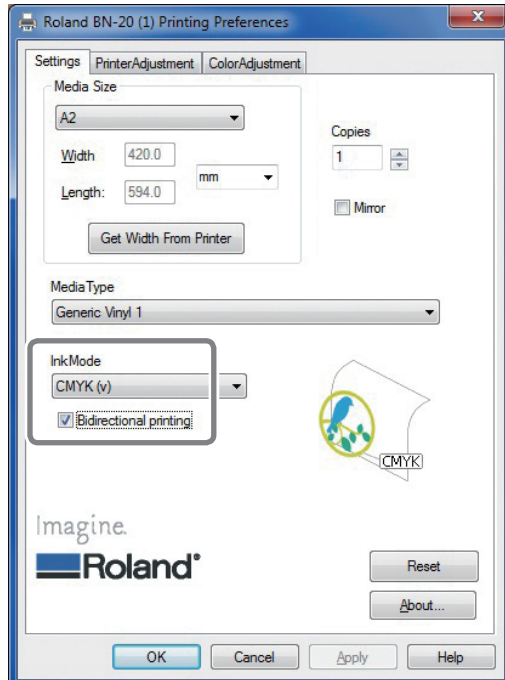

Procedure

1 **Open the Utility window.**

☞ P. 7, "How to Open the Utility Window / Exit the Utility"

2

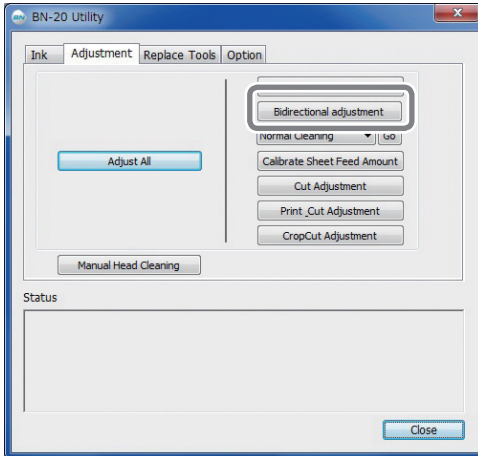

Click [Bidirectional adjustment].

3

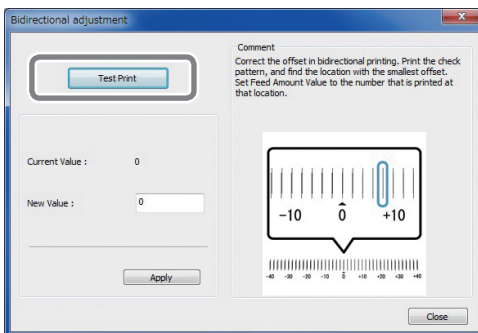

Click [Test Print].

The test pattern is printed.

4 **Read the on-screen instructions and then enter a value in the [New Value] box.**

5 **Click [Apply].**

The value in [Present Value] changes to the entered value.

6 **Click [Close].**

STEP 3: Printing Tests and Normal Cleaning

Procedure

1 Open the Utility window.

⇒ P. 7, "How to Open the Utility Window / Exit the Utility"

2

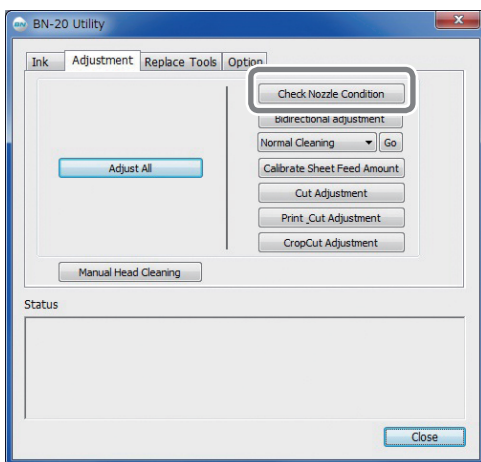

Click [Check Nozzle Condition].

3

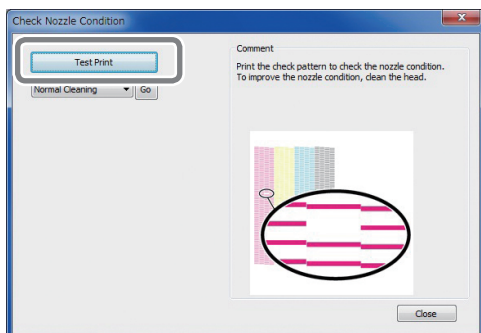

Click [Test Print].

The test pattern is printed. Follow the on-screen instructions and check for dot drop-out.

Nozzle clogging occurs ⇒ Proceed to **4**.
Nozzles are not clogged ⇒ Click [Close].

4

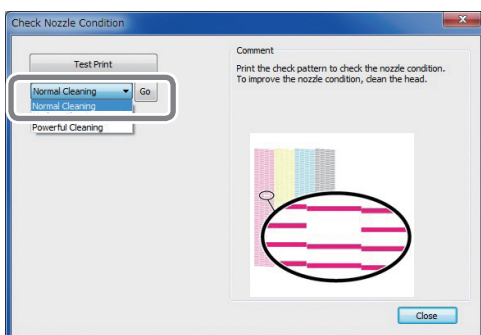

Select [Cleaning Normal] and click [Go].
Normal cleaning starts.

5 To check for nozzle clogging again ⇒ Return to **3**.

If the nozzle clogging is not fixed, perform "Normal Cleaning" again. For information about "Medium Cleaning" and "Powerful Cleaning," refer to page 74 "Medium and Powerful Cleaning."

STEP 4: Calibrate Sheet Feeding Amount

Procedure

- 1 **Open the Utility window.**

☞ P. 7, "How to Open the Utility Window / Exit the Utility"

2

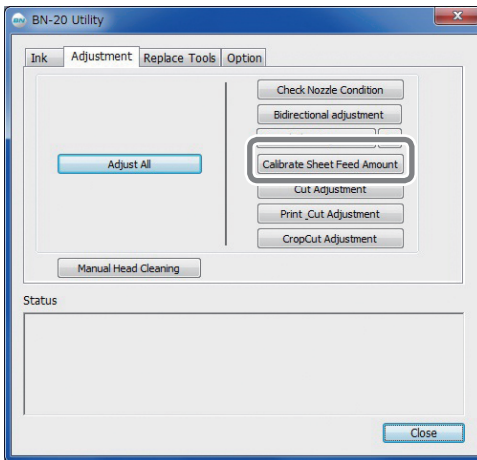

Click [Calibrate Sheet Feeding Amount].

3

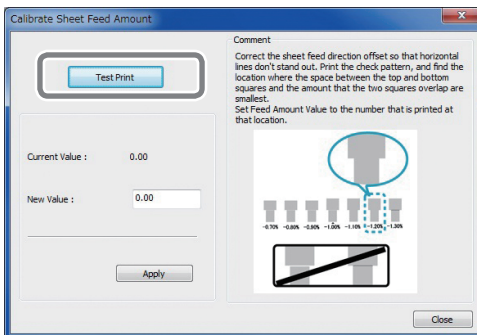

Click [Test Print].

The test pattern is printed.

- 4 **Read the on-screen instructions and then enter a value in the [New Value] box.**

- 5 **Click [Apply].**

The value in [Present Value] changes to the value entered.

- 6 **Click [Close].**

STEP 5: Starting Print Output

This section explains how to output from R-Works.

When outputting from Roland VersaWorks, refer to the "Roland VersaWorks Quick Start Guide" and the "BN-20 Roland VersaWorks Metallic Silver Ink Guide". When outputting from commercially available application software for creating drawings, refer to the documentation supplied with your application software.

Procedure

1 Start R-Works.

☞ P. 8, "How to Start R-Works"

2 Create a drawing.

Refer to "Step 1: Create a new project" and "Step 2: Create the print data" from [Operation Procedures] in the R-Works Help, and create a drawing.

☞ P. 8, "How to Open the BN-20 Driver/R-Works Help"

3 Starting Output

Refer to "Step 4: Outputting" from [Procedure] in the R-Works Help.

4

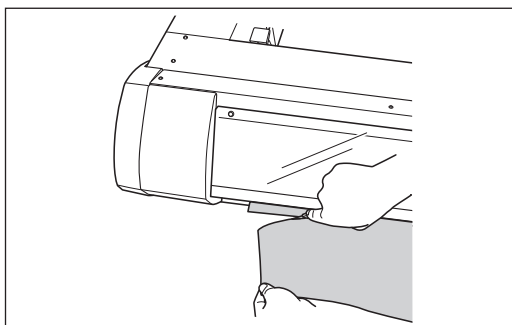

Cut the media when outputting is complete.

Use a commercially-available blade to cut the media.

You can set time for the printer to wait before printing the next page (Dry Time) after output.

☞ P. 63, "Setting of Dry Time"

About the Output-Start Location

The output-start location is always the point shown in the figure below.

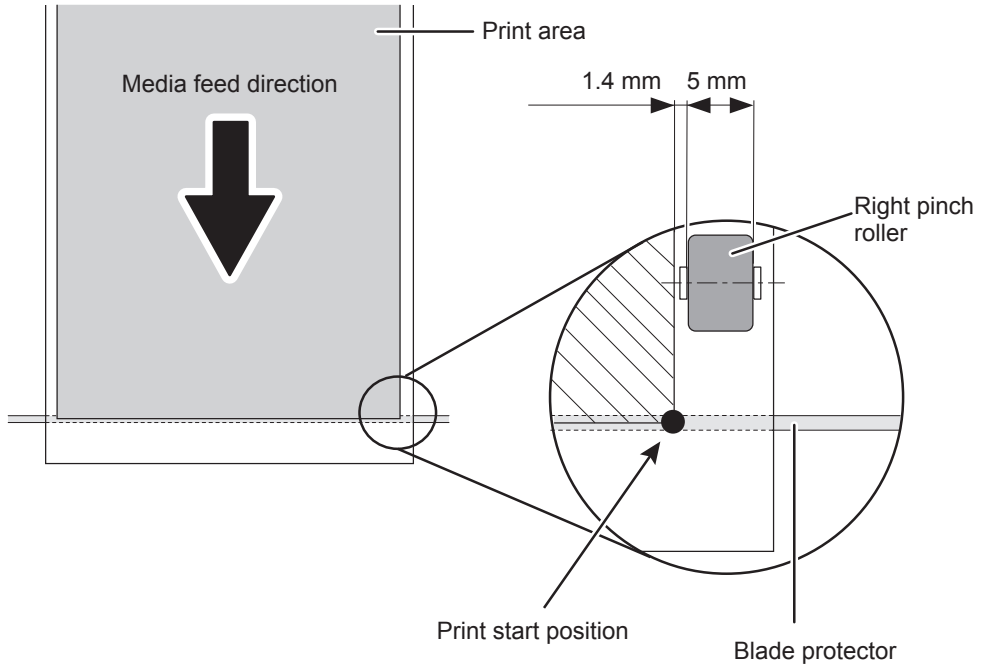

Stopping Print Output

To stop output on the printer side

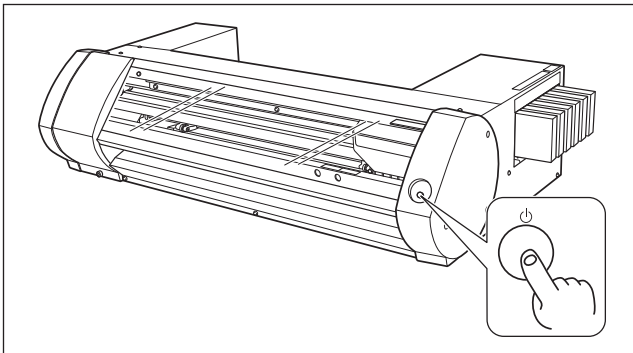

Press and hold down the POWER key for one second or more during output.
Output stops. You cannot resume output from the stop point.

This operation does not cancel standby output data on the computer. Follow the steps below to cancel data that is still on the computer.

Canceling Output from the Computer (canceling standby output data)

Procedure

1 Windows 7

Click [Start] >> [Devises and Printers].

Windows Vista

Click [Start] >> [Control Panel] >> [Hardware and Sound] >> [Printers].

Windows XP

Click [Start] >> [Printers and Faxes].

2

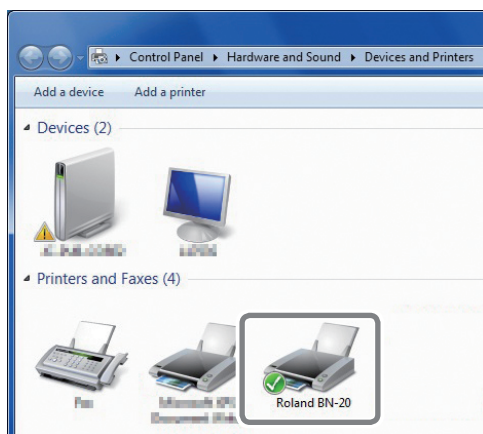

Double-click the BN-20 icon.

3 Click [Printer] >> [Cancel All Documents].

Depending on the computer data transfer status, it may be too late to cancel output. In this case, you need to cancel output from the printer.

Chapter 2

Fully Utilizing the Machine

Cutting / Printing & Cutting.....	28
Adjusting cutting	28
Accurately Adjusting the Cutting-in Amount.....	30
Adjusting printing & cutting	31
Creating Data for Cutting / Printing & Cutting.....	32
Cautionary note on making output with cutting	34
Performing Printing and Cutting Separately.....	35
To Perform Printing and Cutting Separately	35
Printing with Crop Marks	35
Aligning Automatically and Cutting	37
Crop Cut Adjustment	39
Using Metallic Silver Ink.....	40
Characteristics of Metallic Silver Ink and Important Notes.....	40
Creation of Print Data Using Metallic Color (R-Works).....	41
Creation of Print Data Using Metallic Color (General Application for Drawing).....	43
Blend Print and Layered Print.....	45
Blend Print (Metallic Silver + CMYK).....	45
Layered Print (Metallic Silver ⇌ CMYK)	50
Layered Print (CMYK ⇌ Metallic Silver)	55
Printing a Metallic Color Chart (R-Works)	60
Utility : Other Function	62
Performing Various Adjustments Through a Sequence of Operations.....	62
Setting of Dry Time.....	63
Resetting All Adjustments to Factory Default Values.....	66

Cutting / Printing & Cutting

Adjusting cutting

Adjust the cutting conditions to obtain beautiful razor sharp cut lines. Making adjustments to suit the media thickness.

Procedure

1 Load the media to be cut.

☞ P. 14, "STEP1: Loading Media"

2 Open the Utility window.

☞ P. 7, "How to Open the Utility Window / Exit the Utility"

3

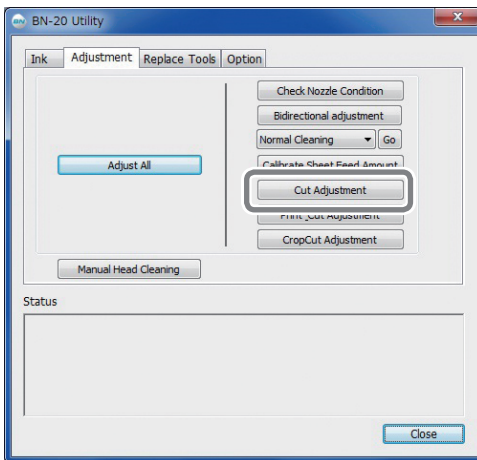

Click [Cut Adjustment].

4

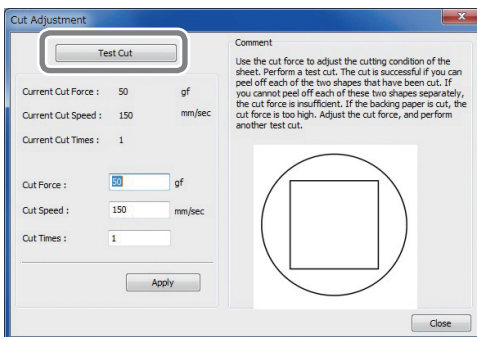

Click [Test Cut].
Test cutting is performed.

5 Enter values in the [Cut Force], [Cut Speed], and [Cut Times] boxes.**Cut Force**

Force at cutting time. If this force is too strong, the blade cuts into the backing paper. (Default setting: 50 gf)

Cut Speed

Cutting speed. If the speed is too fast, the cut line is crooked. (Default setting: 15 cm/sec)

Cut Times

The number of times to cut the same location. If it is impossible to cut even if you adjust the cut force and cut speed, increase the cut times. (Default setting: 1)

Assessment of cutting test results

Check the cut shapes.

The cut shape is crooked ⇒ Decrease the value of [Cut Speed].

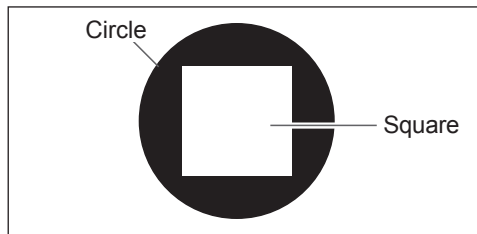

Peel off the circle.

The square also peels off ⇒ Increase the value of [Cut Force].

Some uncut areas remain ⇒ Decrease the value of [Cut Speed].

Peel off the square.

There is a faint blade mark on the backing paper ⇒ Do not change the value of [Cut Force].

The blade mark is indistinct ⇒ Increase the value of [Cut Force].

The blade mark is too deep and the backing paper is also cut ⇒ Decrease the value of [Cut Force].

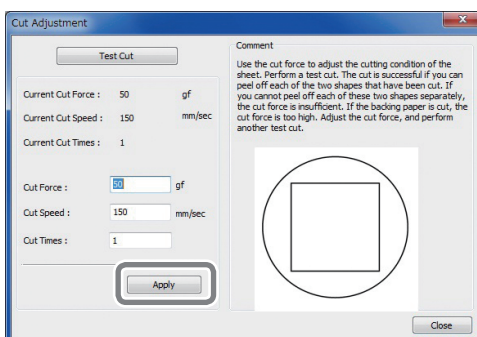
6

Click **[Apply]**.

Repeat **4**, **5** and **6** until correctly adjusted.

7

Click **[Finish]**.

Accurately Adjusting the Cutting-in Amount

When you want to perform accurate and fine adjustment of the cutting-in amount, such as when cutting media with thin backing paper, you can obtain good results by adjusting the tip of the blade. Turn the cap portion of the blade holder to adjust the amount of blade extension. Each indicator tick corresponds to 0.1 millimeters, and adjustment for 0.5 millimeters can be made by rotating the cap one full turn.

Note that making the amount of blade extension too small may cause the tip of the blade holder cap to touch, and may soil and damage the printed surface. It's important to be especially careful about this when you're using media that has poor ink adhesion properties.

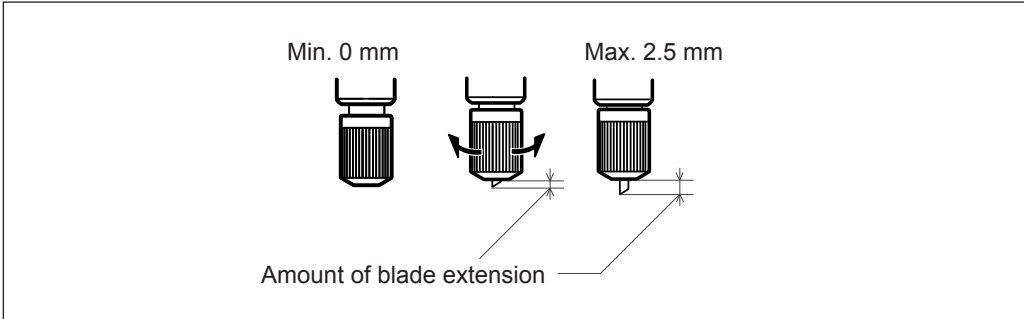

Rough Estimate for the Amount of Blade Extension

Use the following dimension as a rough estimate for setting the amount of blade extension.

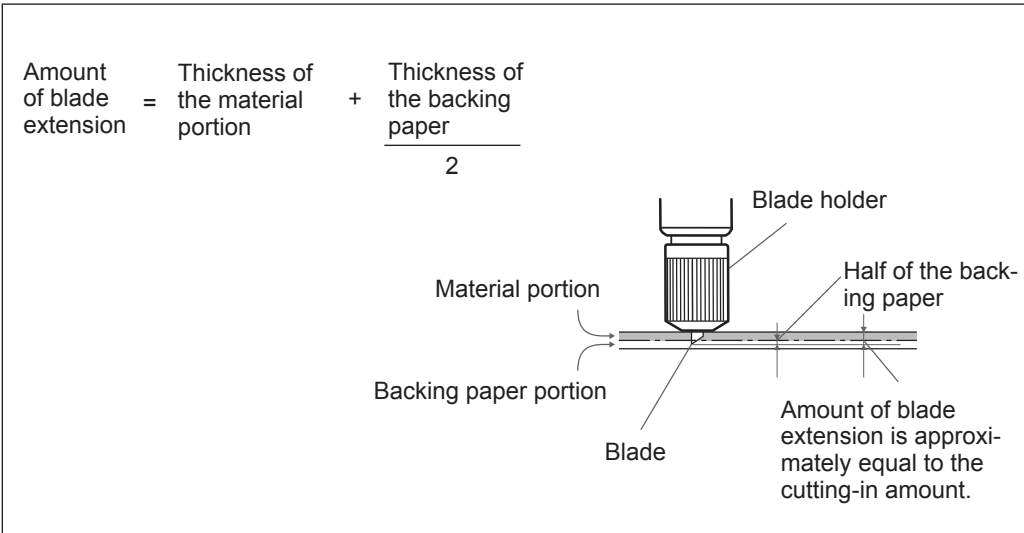

Adjusting printing & cutting

When printing and cutting at the same time, adjust and align the printing and cutting positions. Depending on the media thickness, sometimes printing and cutting positions are very slightly out of alignment. It is recommended to set correction values to suit the media.

Procedure

1 Load the media to be cut.

☞ P. 14, "STEP1: Loading Media"

2 Open the Utility window.

☞ P. 7, "How to Open the Utility Window / Exit the Utility"

3

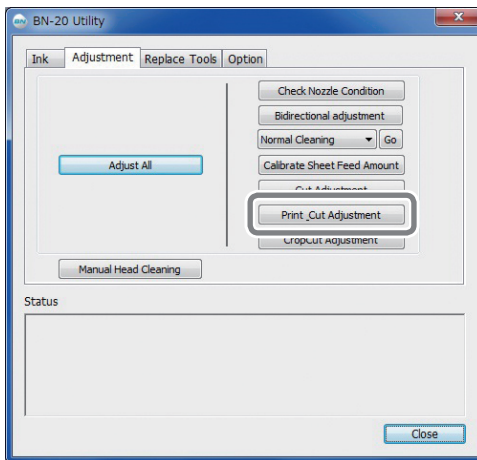

Click [Print_Cut Adjustment].

4

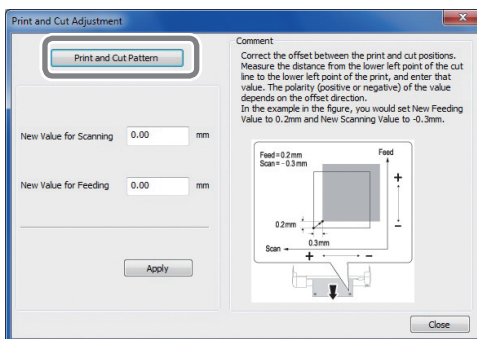

Click [Print and Cut Pattern].

The test pattern is printed.

5 Follow the on-screen instructions and enter the values for [New Value for Scanning] and [New Value for Feeding].

6 Click [Apply].

The values in [New Value for Scanning] and [New Value for Feeding] change to "0."

7 Click [Close].

Creating Data for Cutting / Printing & Cutting

* When using Roland VersaWorks, refer to the "Roland VersaWorks Quick Start Guide".

When using R-Works

Open the R-Works Help, display [Contents] - [Procedure], and then refer to the instructions from "Introduction" to "Step 4: Outputting".

☞ P. 8, "How to Open the BN-20 Driver / the R-Works Help"

When using application software to create drawings

Verified application software

- Adobe Illustrator CS5/CS4/CS3
- Corel DRAW X5/X4/X3

1. Set the color that the BN-20 driver will identify as the cutting line.

1 Display the BN-20 driver's Printing Preferences screen.

☞ P. 6, "How to Open the BN-20 Driver's Printing Preferences Screen"

2

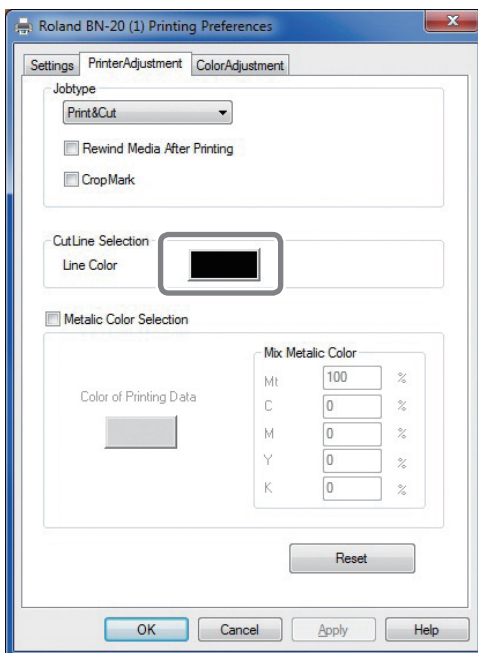

Click the [Line Color] button from [CutLine Selection] on the [Printer Adjustment] tab.

3

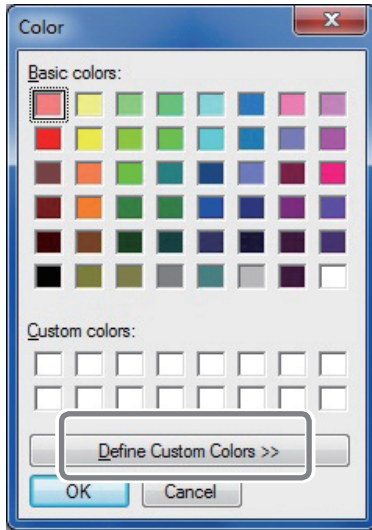

Click **[Define Custom Colors]**.

The Color Settings screen opens allowing you to create colors.

4

Enter values for **[Red (R)]**, **[Green (G)]**, and **[Blue (B)]**.

The BN-20 driver identifies the color specified using the values entered here as the cutting line, and outputs the color.

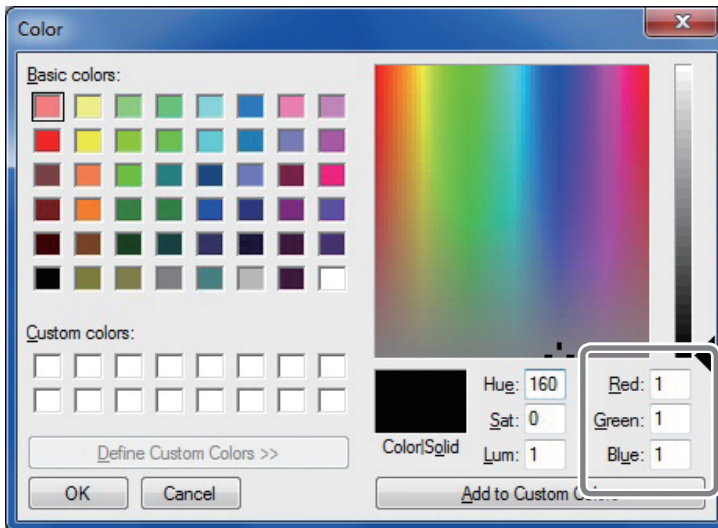

2. Creating Print Data

1

Create the print data using application software for creating drawings.

POINT!

Set the Document Color Mode to [RGB]. The color (RGB value) specified as the metallic color may change because CMYK is converted to RGB when outputting in CMYK mode. In this case, it is not possible to print using a metallic color or to perform cutting be

- 2 Specify the RGB value set for the part to be identified as the cutting line in step 1.-4.
If the color for the part you want to print and the color set in procedure 1.-4 overlap, redo the settings from step 1.-4.
- 3 Specify the line width for cutting lines as follows.
Adobe Illustrator CS5/CS4/CS3: 0.001 pt
CoreIDRAW X5/X4/X3: Hairline
It may not be possible to cut lines of the specified width.

Cautionary note on making output with cutting

Points to Note when Cutting Only

For roll media, let the media hang down to the rear before outputting.

When using the roll media and only performing cutting, let the media hang down to the rear of the machine. This prevents a motor error or fall of the media caused by the media being pulled with excessive force.

Do not cut the media before it is taken back if "Take back after printing" is specified in the BN-20 driver.

Do not cut the media before it is taken back when "Return to home position after printing" is ON in the "Printer Control" tab of the BN-20 driver. If the media is cut before it is taken back, ink might be ejected to a location where there is no media.

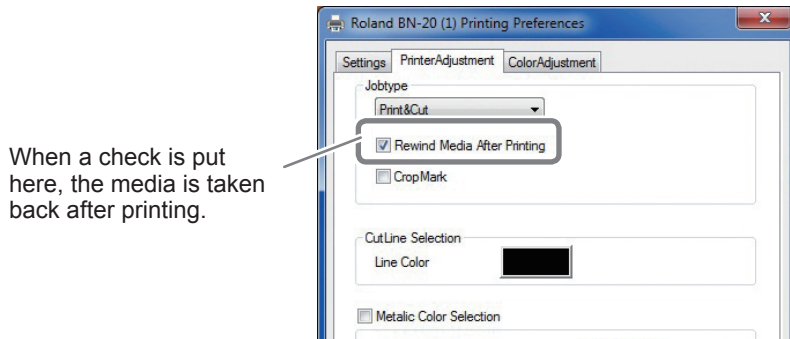

In the case of print & cut, dry the ink sufficiently before cutting.

You can set time for the printer to wait before cutting (Dry Time) with the R-Works, BN-20 driver, or Roland VersaWorks. The dry time varies according to the media.

☞ P. 63, "Setting of Dry Time"

Performing Printing and Cutting Separately

To Perform Printing and Cutting Separately

You can remove the printed media and then reload it and perform cutting.

(Example: Perform lamination or other processing after printing, then reload the media and perform cutting.)

Then, carry out alignment to prevent misalignment of the printing results and the cut lines. Perform this adjustment in the next Procedure.

Procedure

1 Printing with Crop Marks.

☞ P. 35, "Printing with Crop Marks"

2 Align to the printed crop marks and perform cutting.

☞ P. 37, "Aligning Automatically and Cutting"

Printing with Crop Marks

This section describes how to specify settings when using the BN-20 driver. When using Roland VersaWorks, refer to the "Roland VersaWorks Quick Start Guide".

Media Sizes Allowing Automatic Crop Mark Detection

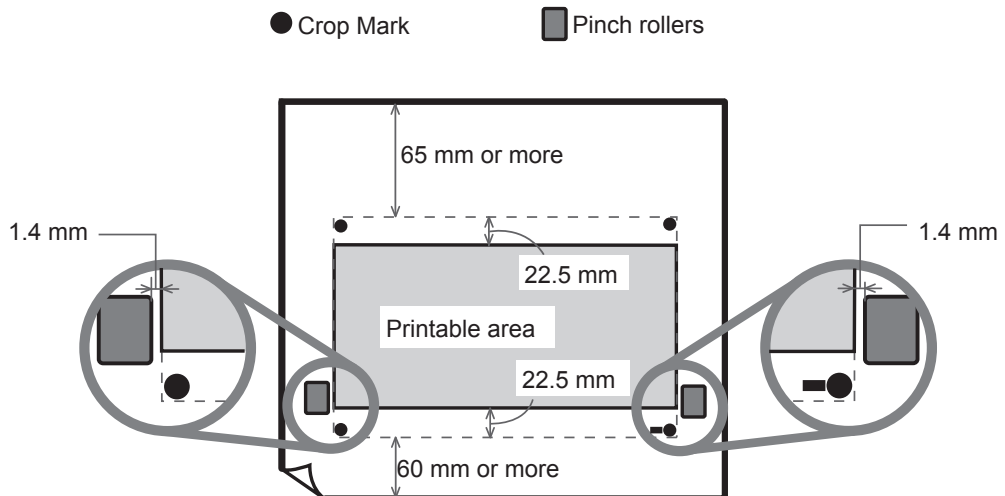

Procedure

1 Display the BN-20 driver's Printing Preferences screen.

☞ P. 6, "How to Open the BN-20 Driver's Printing Preferences Screen"

2

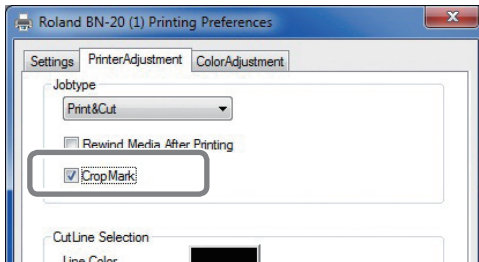

Select [Cropmark] on the [Printer Adjustment] tab.

3

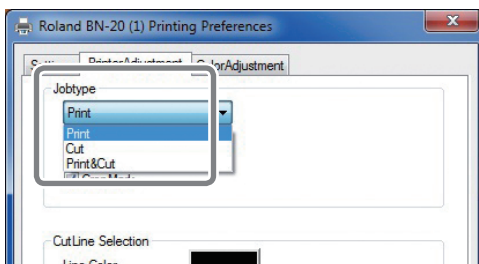

Select [Print].

When [Printing & Cutting] is selected, pull back the media after printing the crop mark to start cutting immediately. Cutting is performed by following the crop mark.

4 Start printing.

☞ P. 23, "STEP 5 : Starting Print Output"

The crop marks are printed as shown in the figure.

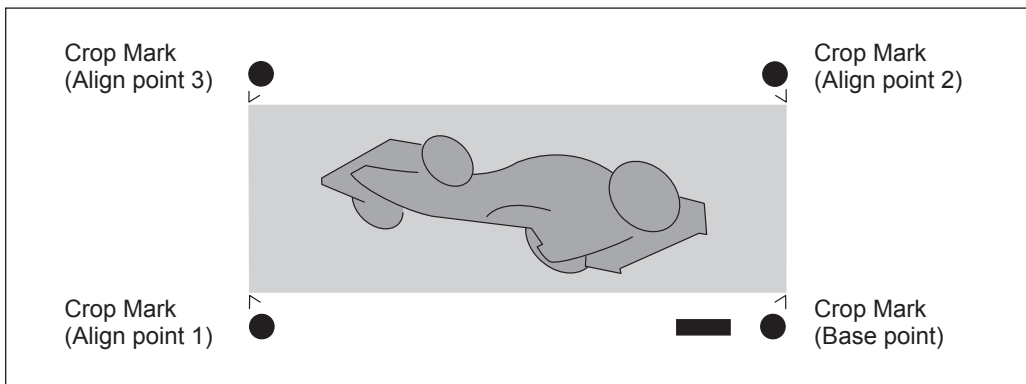

IMPORTANT!

Alignment marks and symbols drawn using a graphics program cannot be used as crop marks.

Aligning Automatically and Cutting

This section describes how to make settings when using the BN-20 driver. When using Roland VersaWorks, refer to the "Roland VersaWorks Quick Start Guide".

Procedure

- 1 **Print with a crop mark, and then reload the media that was removed.**

☞ P. 35, "Printing with Crop Marks"

Points for Media Setting

Place the crop marks on the blade protector.

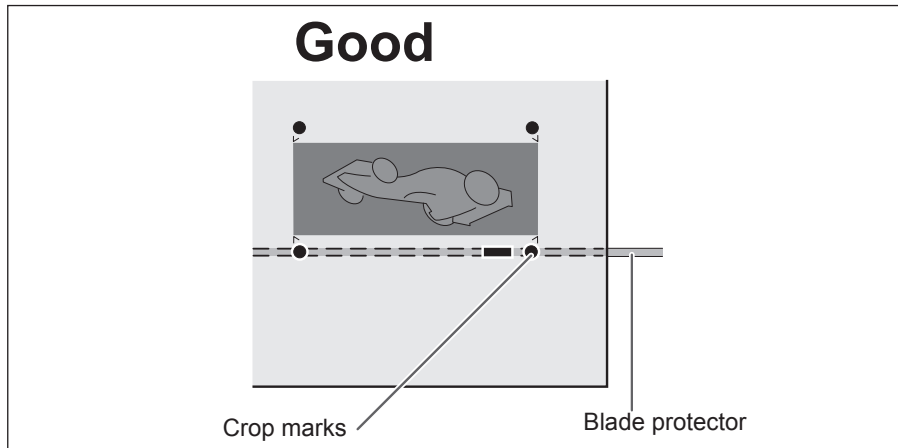

Angled no more than 5 degrees. Otherwise alignment becomes impossible.

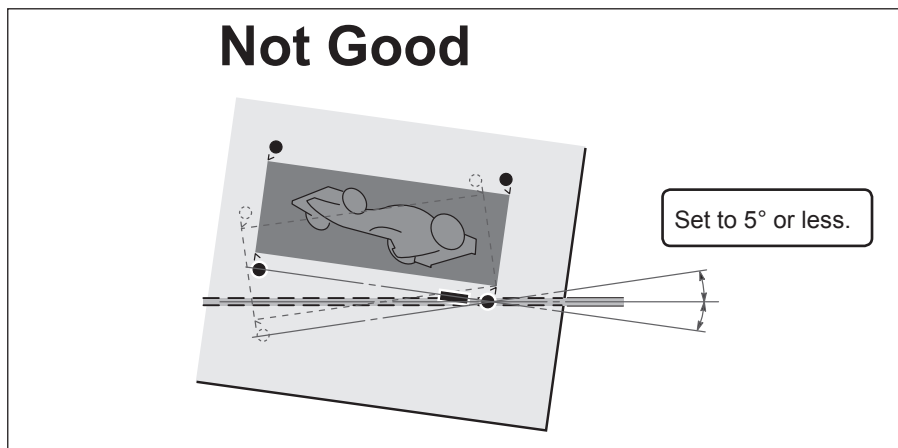

2 Display the BN-20 driver's Printing Preferences screen.

☞ P. 6 "How to Open the BN-20 Driver's Printing Preferences Screen"

3

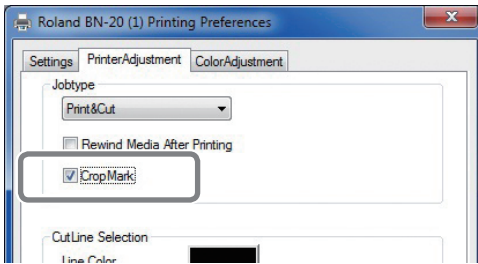

Select [Cropmark] on the [Printer Adjustment] tab.

4

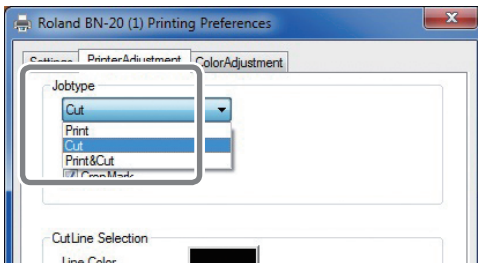

Select [Cut].

5 Start cutting.

☞ P. 23, "STEP 5: Starting Print Output"

Crop Cut Adjustment

Depending on the composition of the media, the positioning of printing and cutting may be misaligned even when you're using crop marks. Make corrections for misaligned printing and cutting for the media you're using.

Procedure

1 Open the Utility window.

☞ P. 7, "How to Open the Utility Window / Exit the Utility"

2

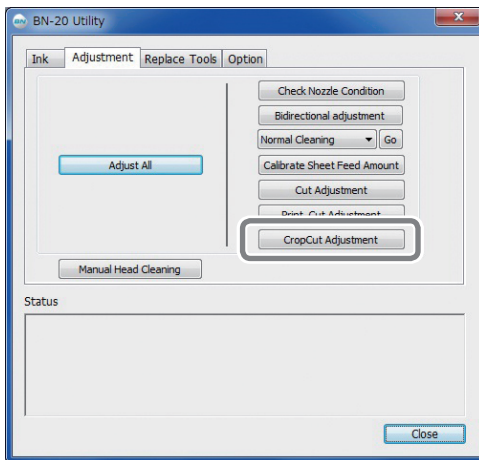

Click [CropCut Adjustment].

3

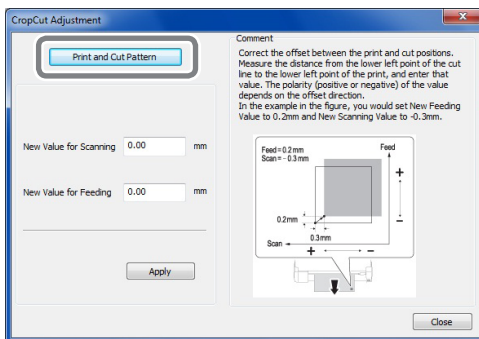

Click [Print and Cut Pattern].

The test pattern is printed.

4 Follow the on-screen instructions and enter the values for [New Value for Scanning] and [New Value for Feeding].

5 Click [Apply].

The values in [New Value for Scanning] and [New Value for Feeding] change to "0."

6 Click [Close].

Using Metallic Silver Ink

Characteristics of Metallic Silver Ink and Important Notes

The usage and handling of metallic silver ink involve some important considerations that do not apply to ink of other colors. Be sure to familiarize yourself with the characteristics of the inks before you use them.

Metallic silver ink precipitate.

The ingredients in metallic silver ink tend to settle. If they are allowed to stand, the precipitates in them may solidify and cause clogging of the print heads or other malfunction.

Before Starting the Day's Work

Remove only the metallic silver ink cartridge once, shake it gently, and set it in before starting the operation for the day.

Drying inks

After output, allow the ink to dry sufficiently. Note that metallic silver ink in particular require printing at a high density, and so are more difficult to dry than CMYK inks. You can set time for the printer to wait before printing the next page (Dry Time) after output.

☞ P. 63, "Setting of Dry Time"

We strongly recommend lamination.

Depending on conditions, the weatherability of metallic silver ink may be inferior to that of CMYK inks. Therefore, laminating is strongly recommended.

Creation of Print Data Using Metallic Color (R-Works)

* When using Roland VersaWorks, refer to the "Roland VersaWorks Quick Start Guide" and the "BN-20 Roland VersaWorks Metallic Silver Ink Guide".

Procedure

1 Start R-Works.

☞ P. 8, "How to Start the R-Works"

2 Create a new project and draw a figure.

Refer to R-Works Help for information on R-Works basic operations.

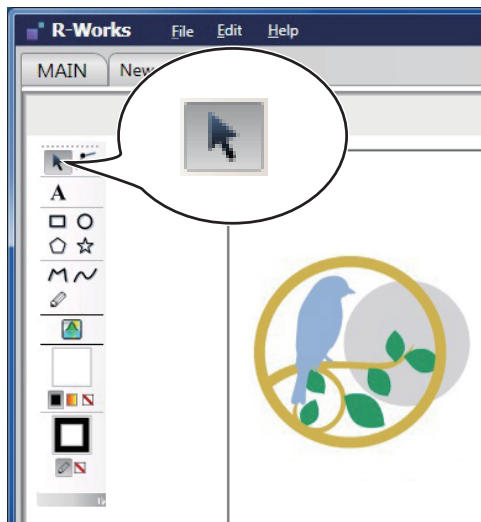

3

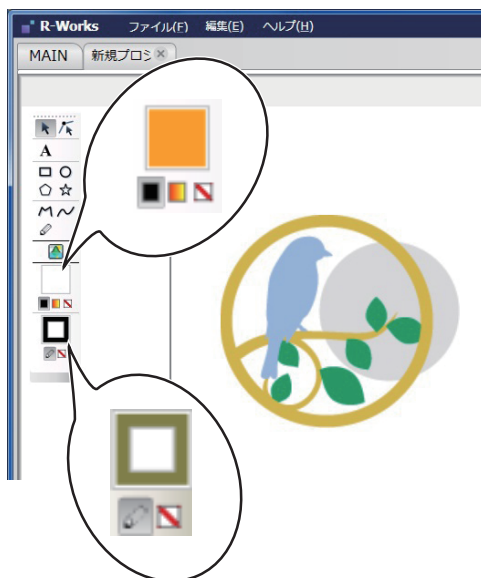

Click , and select the part where you want to use a metallic color.

4



When specifying a line: click , and then click  (when specifying the color of the line).

When specifying a solid section: click , and then click .

The [Specify Color] screen opens.

5 Select [Spot Color].

You can now specify a metallic base color or plain silver.

Metallic

This color is a metallic color created by mixing CMYK ink and metallic silver ink.

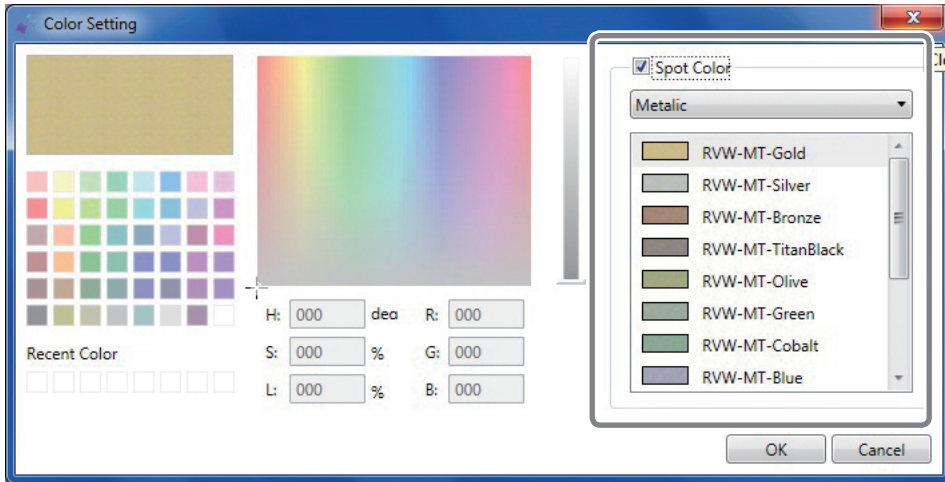

Silver

This is the color of metallic silver ink by itself. You can specify the density.

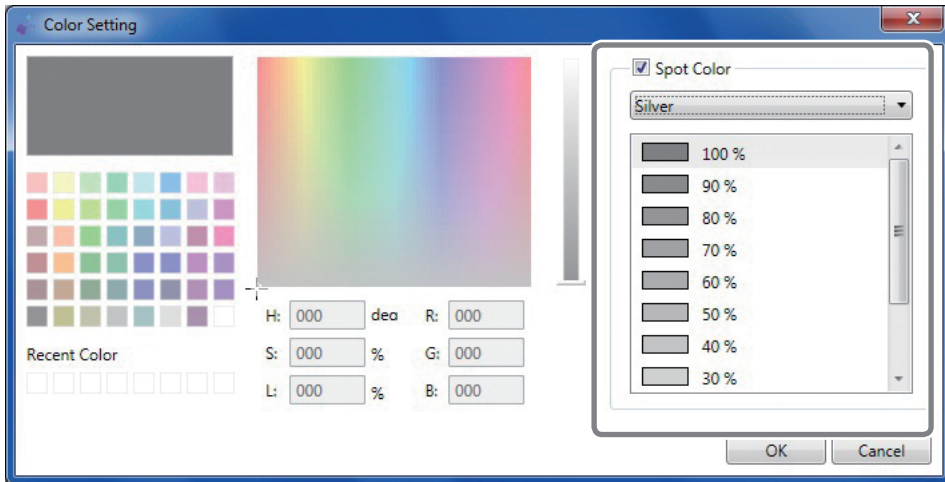

6 Specify the color, and then click [OK].

Creation of Print Data Using Metallic Color (General Application for Drawing)

* When using Roland VersaWorks, refer to the "Roland VersaWorks Quick Start Guide" and the "BN-20 Roland VersaWorks Metallic Silver Ink Guide".

Verified application software

- Adobe Illustrator CS5/CS4/CS3
- Corel DRAW X5/X4/X3

1. Set the color that the BN-20 driver will identify as the metallic color.

1 Display the BN-20 driver's Printing Preferences screen.

☞ P. 6, "How to Open the BN-20 Driver's Printing Preferences Screen"

2 Select [Metallic Color Selection] on the [Printer Adjustment] tab.

3 Click [Color of Printing Data].

The [Color] screen opens.

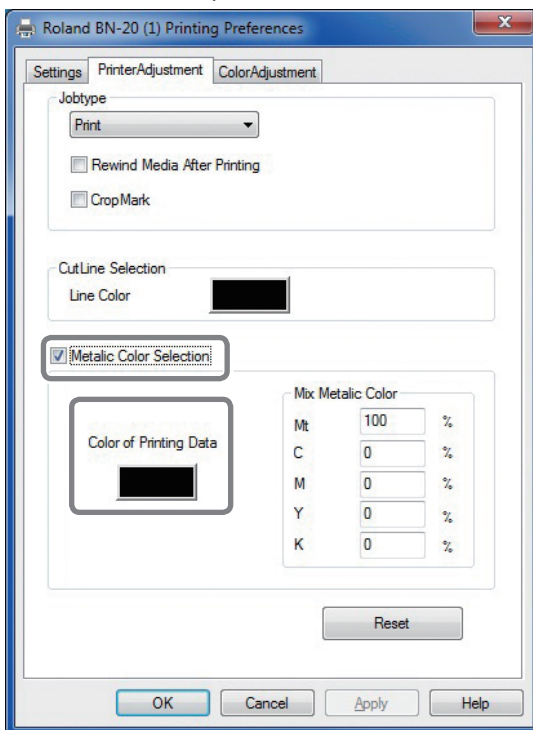

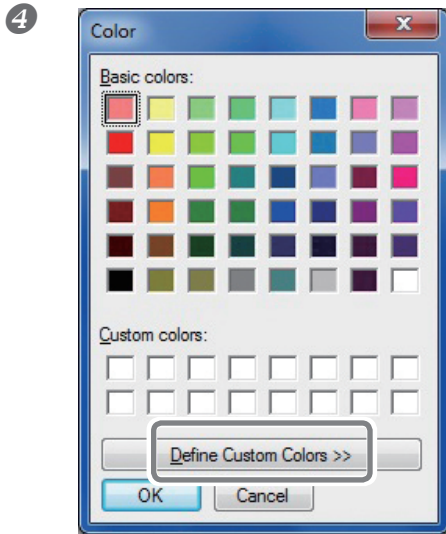

4 Click [Define Custom Colors].

The Color Settings screen opens allowing you to create colors.

5 Enter values for [Red (R)], [Green (G)], and [Blue (B)].

The BN-20 driver identifies the color specified using the values entered here as the metallic color used in printing, and outputs the color.

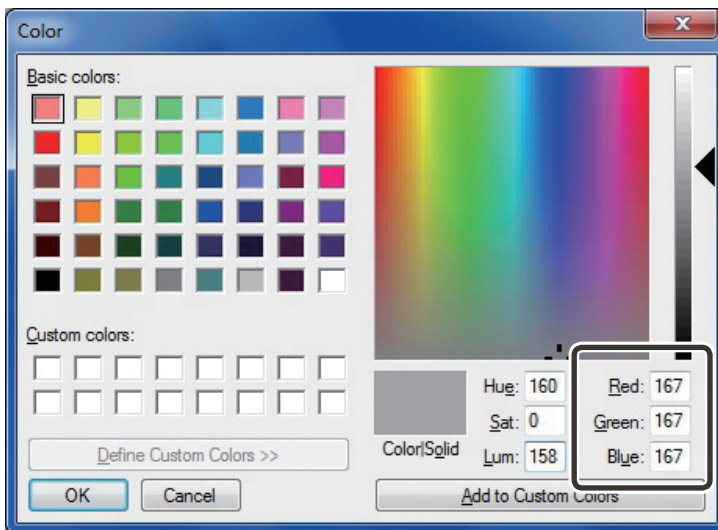

2. Creating Print Data

1 Create the print data using application software for creating drawings.

POINT!

Set the Document Color Mode to [RGB]. Because CMYK is converted to RGB when outputting in CMYK mode, the color (RGB value) specified as the cutting line may change. In this case, it is not possible to print using a metallic color or to perform cutting because the color specified for the driver as the cutting line and the color output from the application software differ.

2 Specify the RGB value set for the part to be printed using a metallic color in step 1.-5.

If the color for the part you do not want to print using the metallic color set in step 1.-5 overlaps, redo the settings from step 1.-5.

Blend Print and Layered Print

Blended printing and layered printing are printing methods that allow you to combine metallic silver ink and CMYK ink. Metallic ink expressions that cannot be created can be realized with just CMYK inks. The printing method differs for blended printing and

⇒ P. 45, "Blend Print (Metallic Silver + CMYK)," p. 50, "Layered Print (Metallic Silver ⇒ CMYK)," p. 55, "Layered Print (CMYK ⇒ Metallic Silver)"

POINT!

Blended printing and layered printing are printing methods that allow you to combine metallic silver ink and CMYK ink. Metallic ink expressions that cannot be created can be realized with just CMYK inks. The printing method differs for blended printing and layered printing, and the metallic impression rendered by CMYK is different. You can make blended printing and layered printing selections by selecting [Ink Mode] in R-Works or the BN-20 driver. Select the best type to suit your situation.

Blend Print (Metallic Silver + CMYK)

This section describes how to perform the blend print with the metallic silver ink and CMYK ink.

⇒ P. 45, "Blend Print and Layered Print"

To perform the blend print, you need to use the printing data where the use of the metallic silver ink and the CMYK ink is designated.

⇒ P. 41, "Creation of Print Data Using Metallic Color (R-Works)," p. 43 "Creation of Print Data Using Metallic Color (General Application for Drawing)"

(Image of printing method)

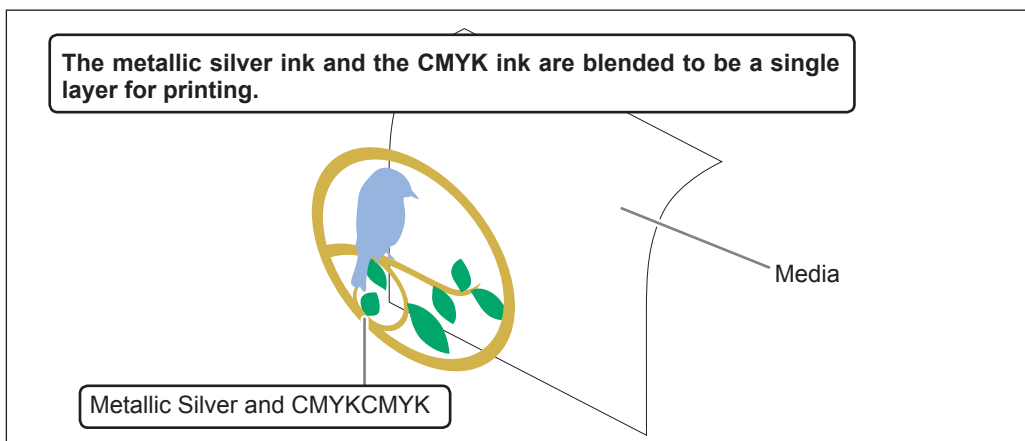

When using R-Works

Procedure

1 **Creating print data.**

☞ P. 41, "Creation of Print Data Using Metallic Color (R-Works)"

2 Click .

The [Output Settings] screen opens.

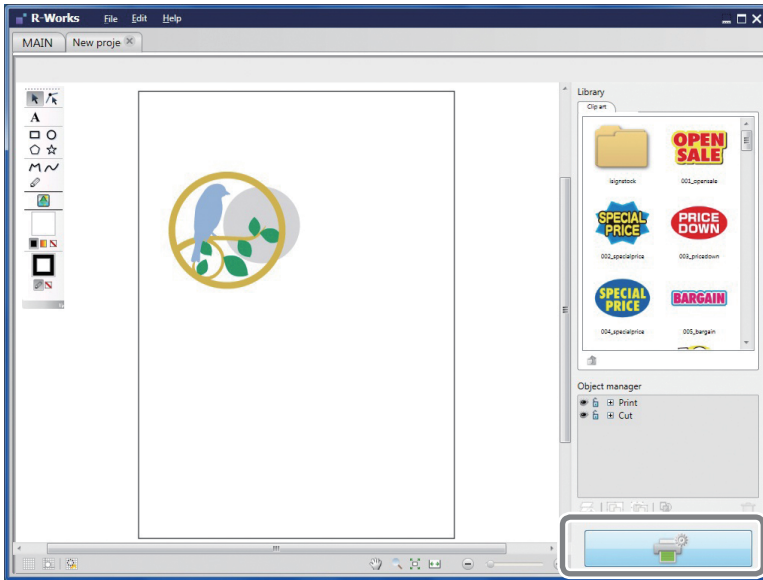

3 Click  from [Printing Preferences].

The [Printing Preferences] settings are displayed.

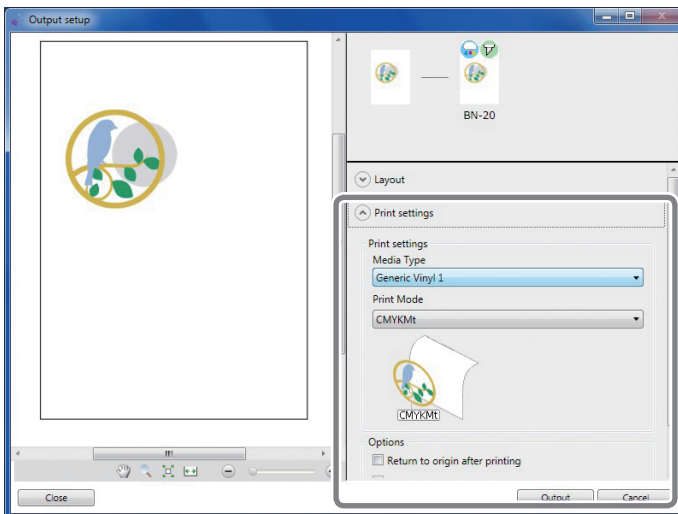

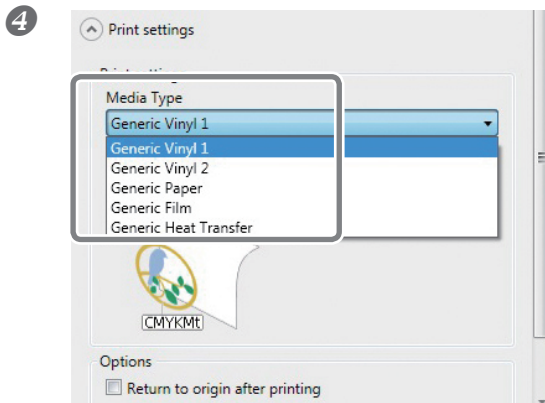

Select [Media Type].

Select the media you are using.

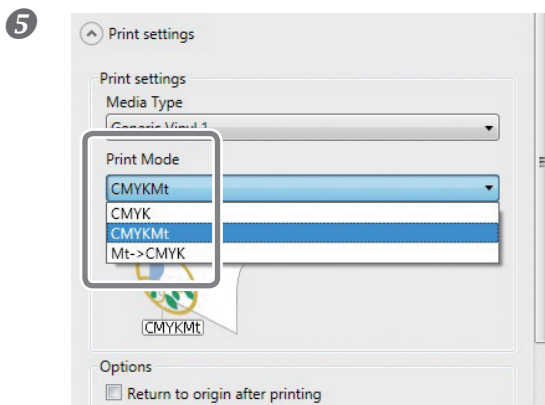

Select [CMYKt] from [Ink Mode].

POINT!

Although you can set the [Media Type] and [Ink Mode] from the BN-20 driver's Printing Preferences, when outputting from R-Works, the settings in R-Works take priority.

6 Click [Output].

When using application software to create drawings

Procedure

1 Creating print data.

⇨ P. 43, "Creation of Print Data Using Metallic Color (General Application for Drawing)"

2 Open the BN-20 driver's Printing Preferences screen.

⇨ P. 6, "How to Open the BN-20 Driver's Printing Preferences Screen"

3

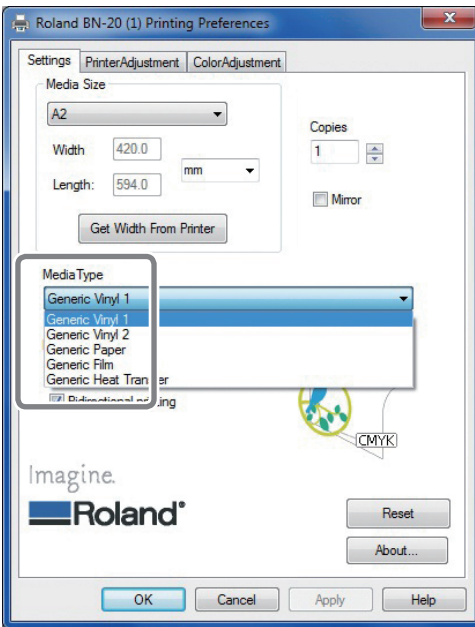

Select [Media Type] on the [Settings] tab.
Select the media you are using.

4

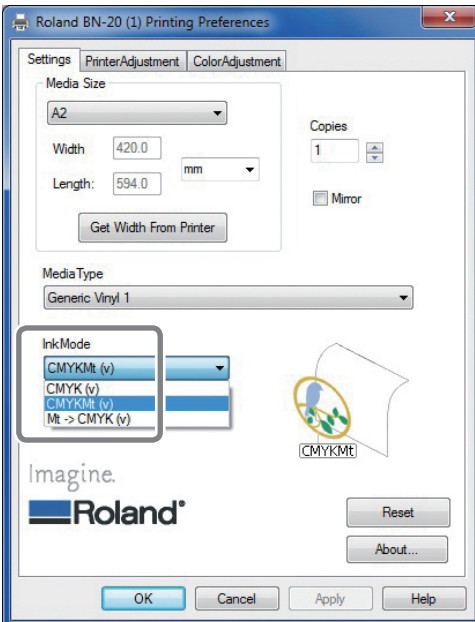

Select [CMYK(v)] from [Ink Mode] on the [Settings] tab.

5

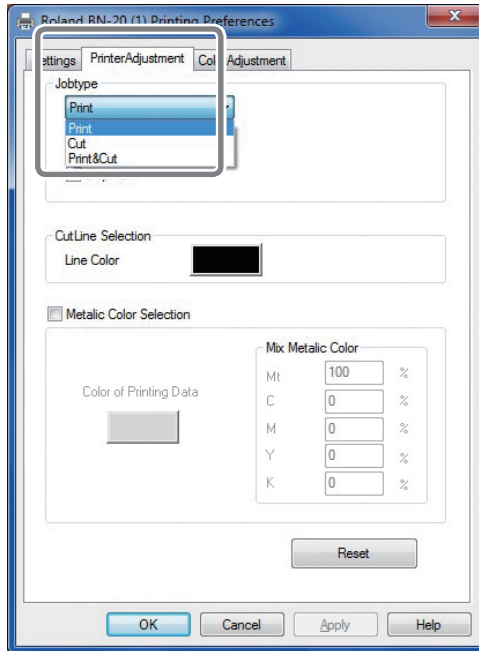

Select [Job Type] on the [Printer Adjustment] tab.

6

Click [OK].

The BN-20 driver's Settings screen closes.

7

Output the print data from the application software.

For more information on using the application software, refer to the documentation supplied with your application software.

Layered Print (Metallic Silver ⇨ CMYK)

This section describes how to perform the layered print with the metallic silver ink and CMYK ink using the metallic silver ink as background.

⇨ P. 45, "Blend Print and Layered Print"

To perform the layered print, you need to use the printing data where the use of the metallic silver ink and the CMYK ink is designated.

⇨ P. 41, "Creation of Print Data Using Metallic Color (R-Works)," p. 43, "Creation of Print Data Using Metallic Color (General Application for Drawing)"

(Image of printing method)

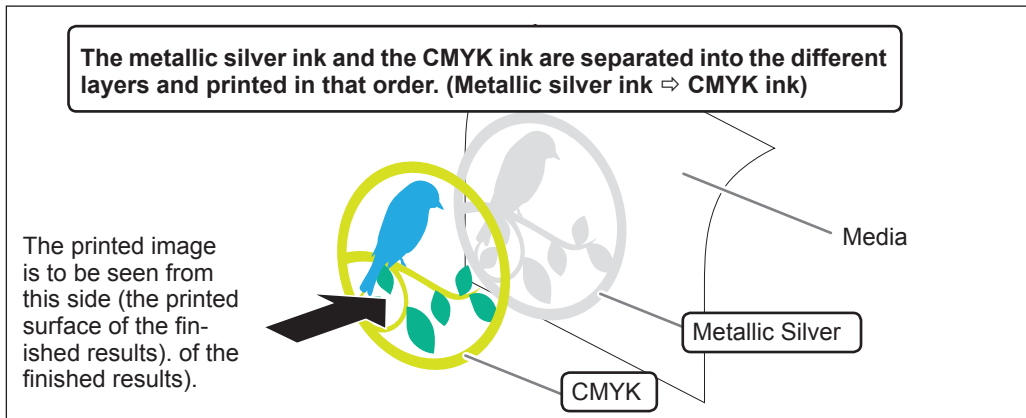

When using R-Works

Procedure

1 Create print data.

⇨ P. 41, "Creation of Print Data Using Metallic Color (R-Works)"

2 Click .

The [Output Settings] screen opens.

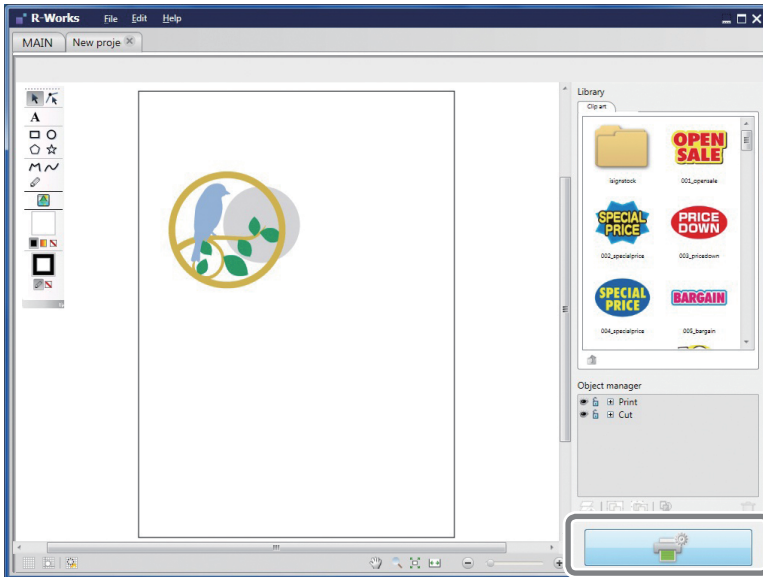

3 Click  from [Printing Preferences].

The [Printing Preferences] settings are displayed.

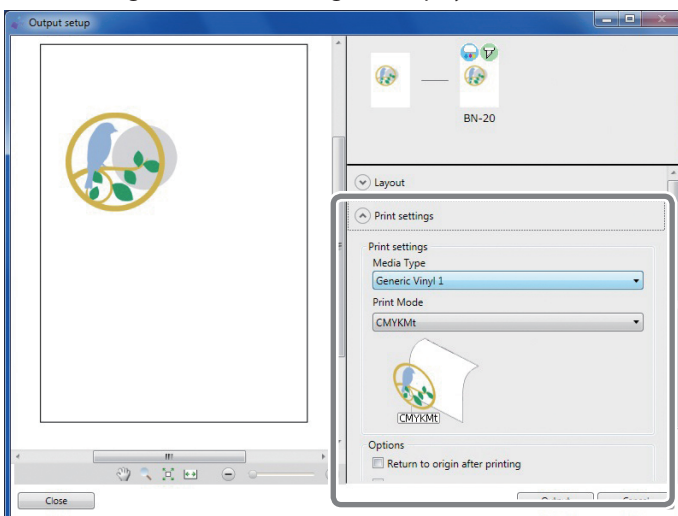

4

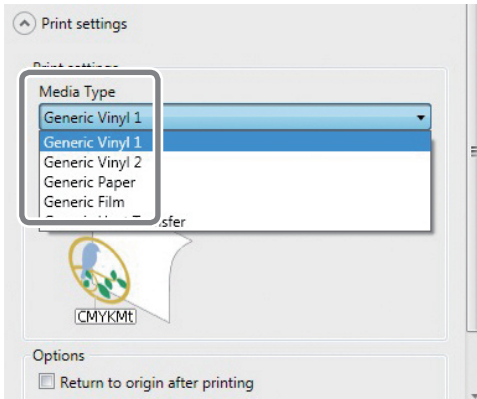

Select [Media Type].

Select the media you are using.

5

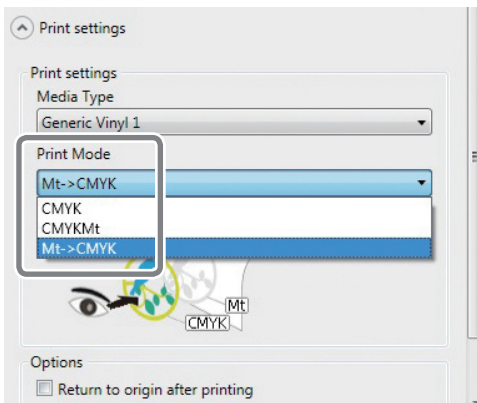

Select [Mt->CMYK] from [Ink Mode].

POINT!

Although you can set the [Media Type] and [Ink Mode] from the BN-20 driver's Printing Preferences, when outputting from R-Works, the settings made in R-Works take priority.

6

Click [Output].

When using application software to create drawings

Procedure

1 Creating print data.

☞ P. 43, "Creation of Print Data Using Metallic Color (General Application for Drawing)"

2 Open the BN-20 driver's Printing Preferences screen.

☞ P. 6, "How to Open the BN-20 Driver's Printing Preferences Screen"

3

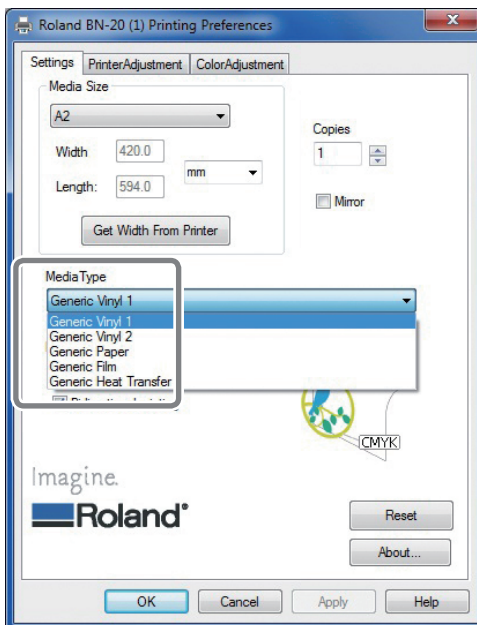

Select [Media Type] on the [Settings] tab.

Select the media you are using.

4

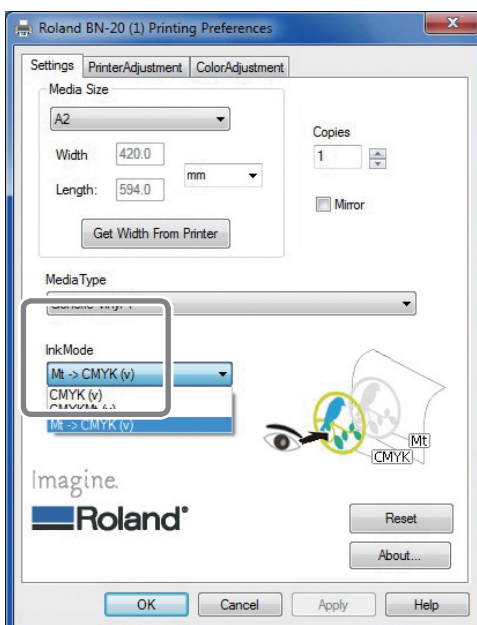

Select [CMYK(v)] from [Ink Mode] on the [Settings] tab.

5

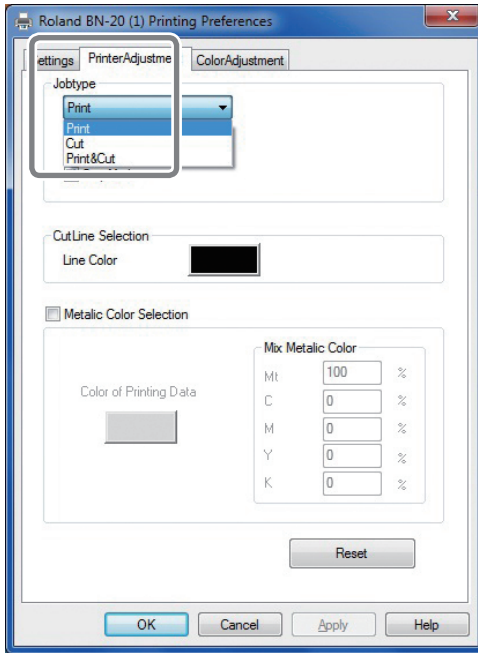

Select [Job Type] on the [Printer Adjustment] tab.

6

Click [OK].

The BN-20 driver's Settings screen closes.

7

Output the print data from the application software.

For more information on using the application software, refer to the documentation supplied with your application software.

Layered Print (CMYK ⇒ Metallic Silver)

This section describes how to perform the layered print with the metallic silver ink and CMYK ink using the CMYK ink as background.

⇒ P. 45, "Blend Print and Layered Print"

To perform the layered print, you need to use the printing data where the use of the metallic silver ink and the CMYK ink is designated.

⇒ P. 41, "Creation of Print Data Using Metallic Color (R-Works)," p. 43 "Creation of Print Data Using Metallic Color (General Application for Drawing)"

(Image of printing method)

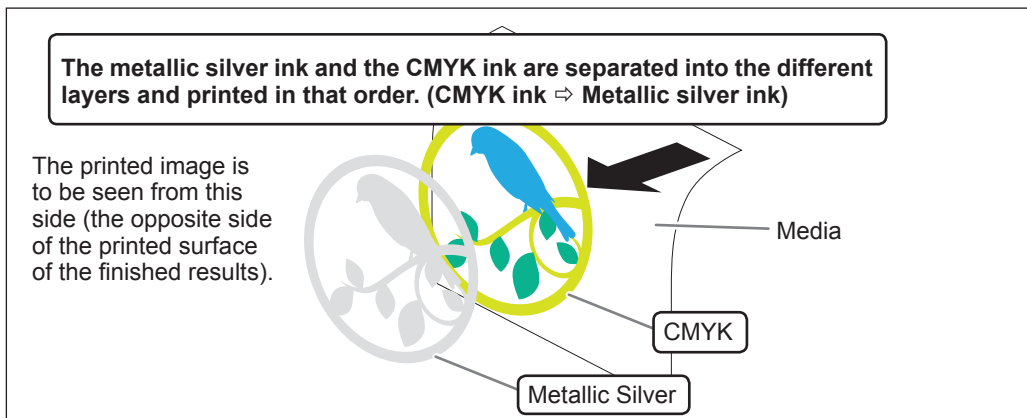

When using R-Works

Procedure

1 Create print data.

☞ P. 41, "Creation of Print Data Using Metallic Color (R-Works)"

2 Click .

The [Output Settings] screen opens.

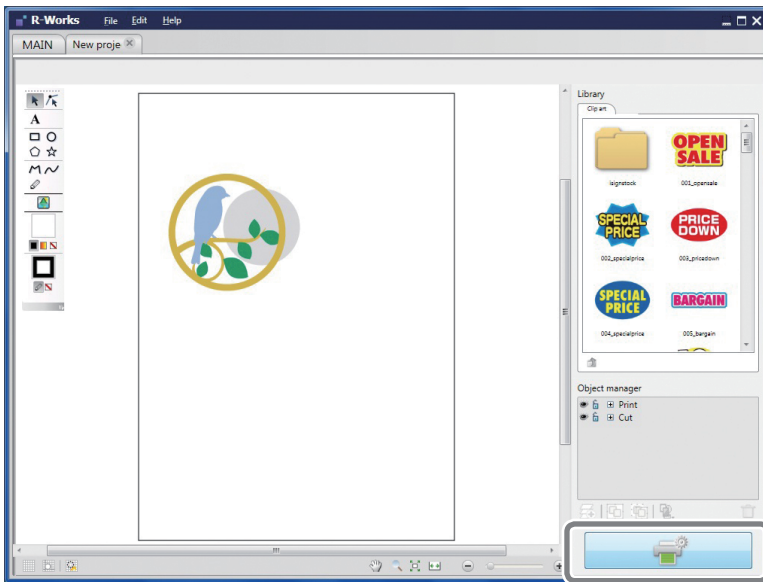

3 Click  from [Printing Preferences].

The [Printing Preferences] settings are displayed.

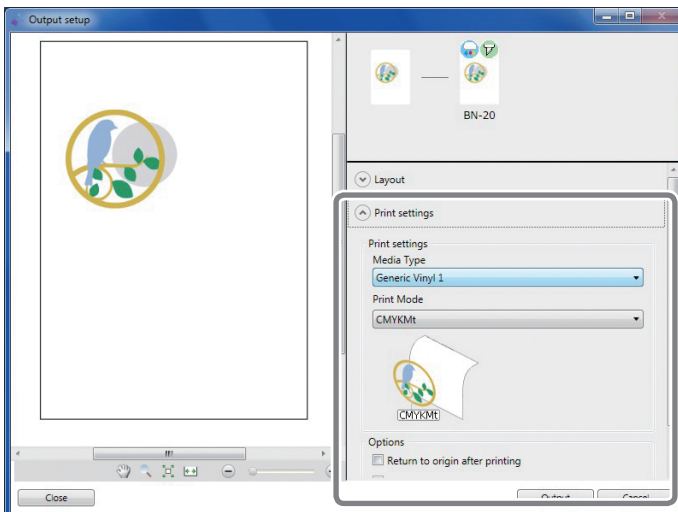

4

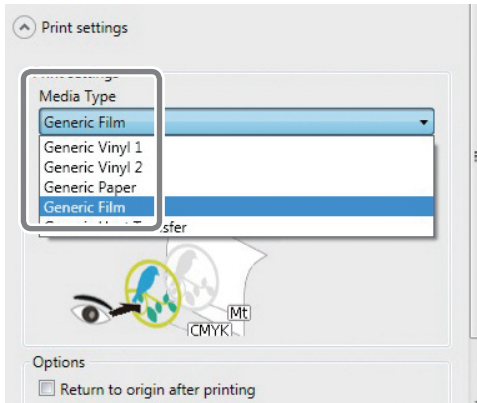

Select [Standard Film] from [Media Type].

5

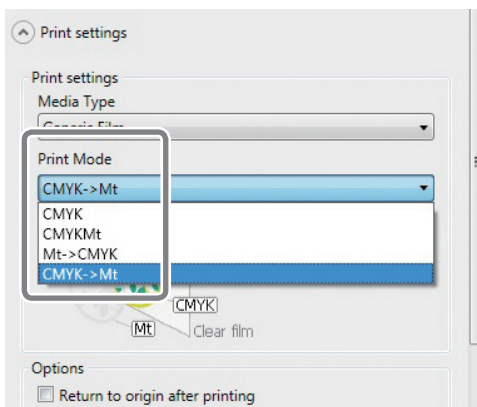

Select [CMYK->Mt] from [Ink Mode].

POINT!

Although you can set the [Media Type] and [Ink Mode] from the BN-20 driver's Printing Preferences, when outputting from R-Works, the settings in R-Works take priority.

6 Click [Output].

When using application software to create drawings

Procedure

1 Creating print data.

⇨ P. 43, "Creation of Print Data Using Metallic Color (General Application for Drawing)"

2 Open the BN-20 driver's Printing Preferences screen.

⇨ P. 6, "How to Open the BN-20 Driver's Printing Preferences Screen"

3

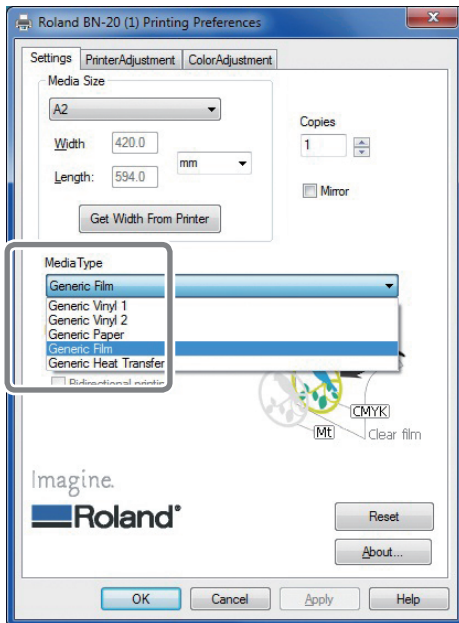

Select [Standard Film] from [Media Type] on the [Settings] tab.

4

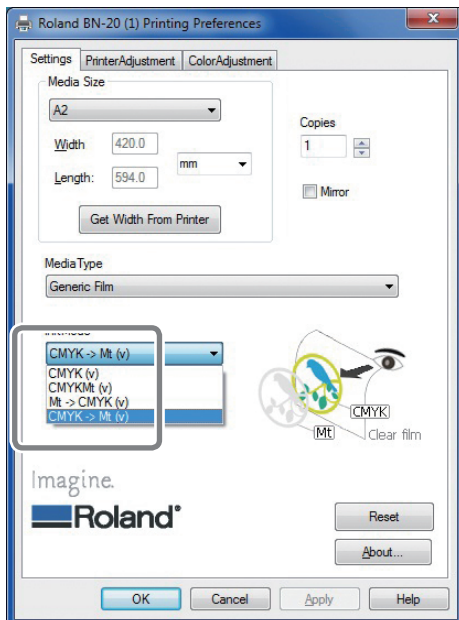

Select [CMYK->Mt (v)] from [Ink Mode] on the [Settings] tab.

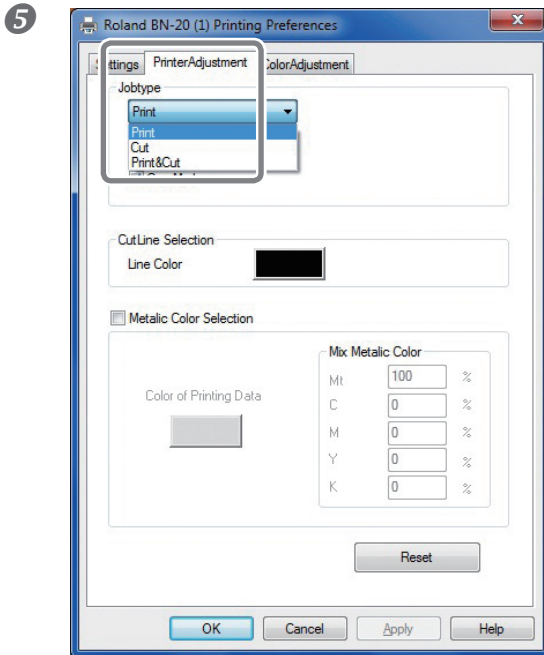

Select [Job Type] on the [Printer Adjustment] tab.

6 **Click [OK].**

The BN-20 driver's Settings screen closes.

7 **Output the print data from the application software.**

For more information on using the application software, refer to the documentation supplied with your application software.

Printing a Metallic Color Chart (R-Works)

The Metallic Color Chart is the printing sample of the special metallic color. By printing the Metallic Color Chart, you can confirm the “complete metallic color chart” representing the special metallic color itself that can be printed with “Your Printer” and “Your Media” (slight pattern differences is possible to occur depending on the conditions of the printer and media.) By selecting colors from this color chart and creating illustrations with these colors, you can accurately reproduce the desired colors.

Procedure

1 Start R-Works.

☞ P. 8, "How to Start the R-Works"

2 Double-click [Mt Colors] on the [MAIN] tab.

[Mt Colors] opens.

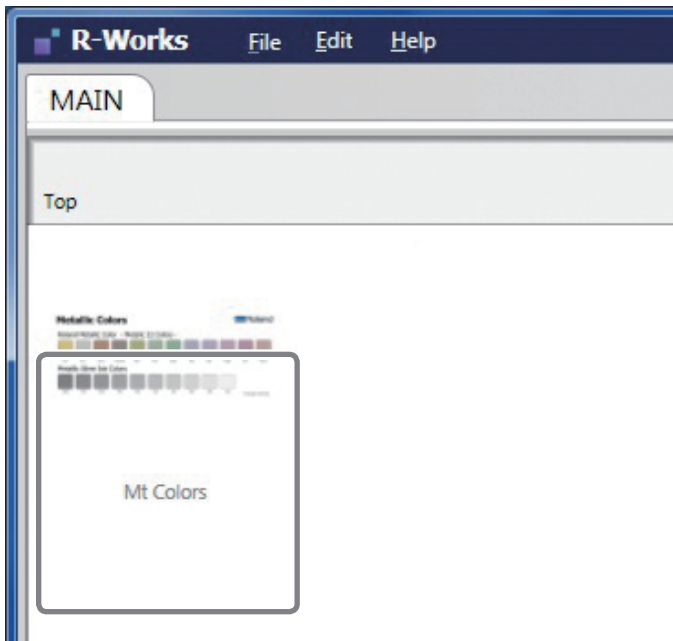

3 Click .

The [Output Settings] screen opens.

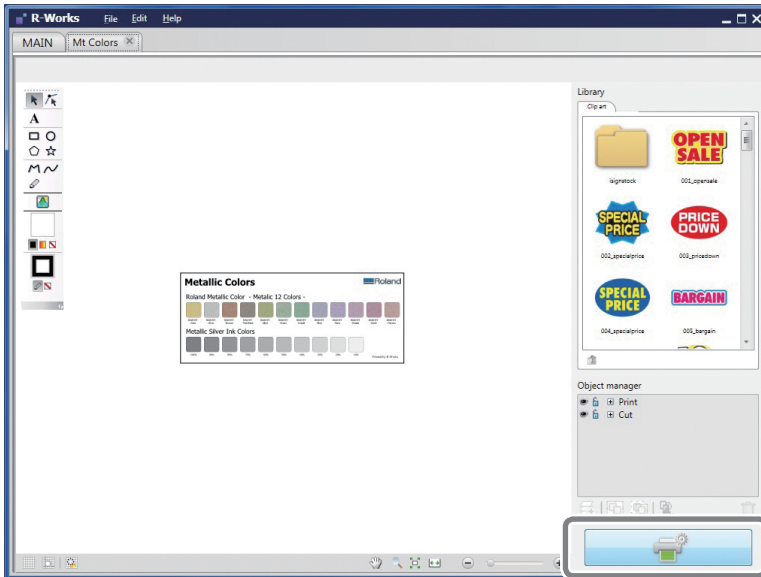

4 Click  from [Layout].

The [Layout] settings are displayed.

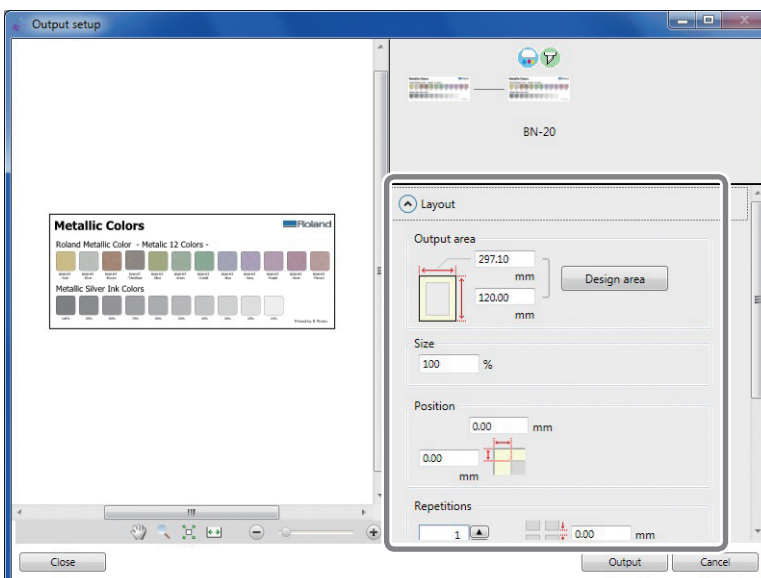

Printing is performed at the size displayed in the [Output Possible Area]. Check the size of the loaded media. If the media size is too small, some areas will not be printed. Replace the media, or use [Size] to reduce the output-area.

5 Click [Output].

Utility : Other Function

Performing Various Adjustments Through a Sequence of Operations

You can perform various output adjustments through a sequence of operations by clicking [Adjust All] on the [Adjustment] tab.

The adjustment method is the same as when adjusting settings individually.

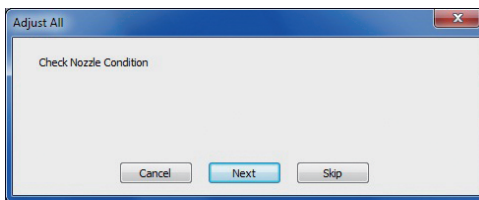
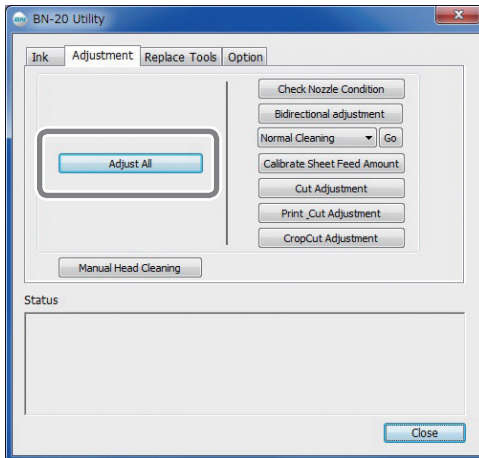

When you click [Adjust All], adjustment information is displayed.

[Next]: Continues to the adjustment screen currently displayed on the screen.

[Skip]: Skips the adjustment currently displayed on the screen.

[Cancel]: Cancels the adjustment process.

The adjustments vary depending on the output method. Refer to the table below.

	Print (Only)	Cutting (Only)	Printing & Cutting	Crop Cut
Check Nozzle Condition	√		√	√
Bidirectional adjustment *	√		√	√
Calibrate Sheet Feed Amount	√	√	√	√
Cut Adjustment		√	√	√
Print Cut Adjustment			√	√
CropCut Adjustment				√

* When printing with CMYK ink only, this is available when bidirectional printing is set in the BN-20 driver.

* Bidirectional printing cannot be performed for print jobs that use metallic silver ink.

Setting of Dry Time

This section explains the method of setting the time that the printer needs to wait before it starts printing or cutting the next page.

Especially, in the case of printing & cutting, ink needs to be sufficiently dried before cutting is started.

When you make output from R-Works

Procedure

- 1 Click  .
The [Output Settings] screen opens.

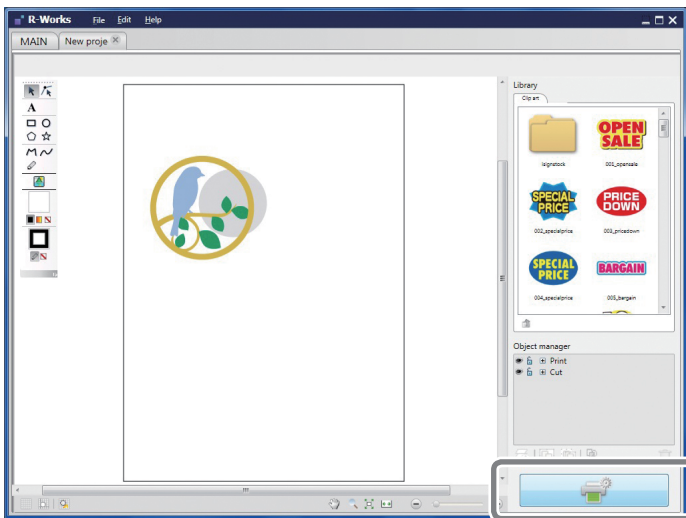

- 2 Click  from [Printing Preferences].
The [Printing Preferences] settings are displayed.

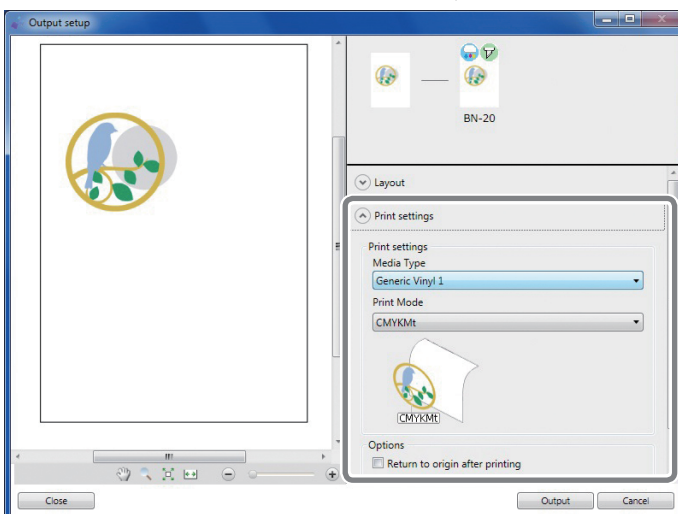

3

Print settings
Media Type: Generic Vinyl 1
Print Mode: CMYK

Options
 Return to origin after printing
 Bidirectional printing

1 Dry Time: 10 Minutes
0
1
3
5
10
15
20
30
60

2 Output Cancel

1 Select [Dry Time] in [Options].
The appropriate setting time varies according to the media. Set longer time when you use a medium on which it takes time to dry ink.

2 Click [Output].
When the printer starts drying, the remaining dry time is displayed on the utility.

If Dry Time is not displayed, scroll down.

The setting in the BN-20 driver is disabled.

Although Dry Time can be set in the BN-20 driver, if you make output from R-Works, priority is given to the setting in R-Works, and the setting in the BN-20 driver is disabled.

When you make output via the BN-20 driver using a general drawing application

Make the following setting in the BN-20 driver first, and then make output from the application.

Procedure

1 Click [Devices and Printers] (or [Printers and Faxes]) from the Start menu (Windows logo) of Windows.

2

Roland BN-20

- See what's printing
- Set as default printer
- Printing preferences**
- Printer properties
- Create shortcut
- Troubleshoot
- Remove device

Right-click the "Roland BN-20" icon, and then click [Printing Preferences].
The BN-20 driver's Printing Preferences screen opens.

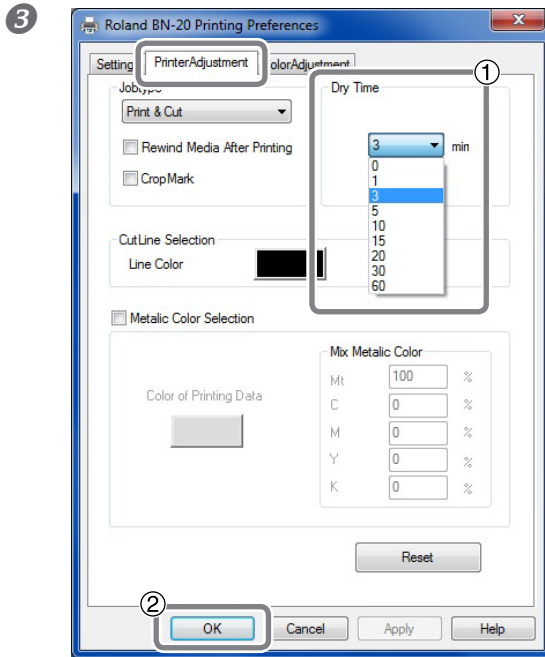

① **Select [Dry Time] in [Options].**

The appropriate setting time varies according to the media. Set longer time when you use a medium on which it takes time to dry ink.

② **Click [Output].**

When the printer starts drying, the remaining dry time is displayed on the utility.

When you make output from Roland VersaWorks

You can set the dry time in Roland VersaWorks as well. For information on its setting method, refer to Help of Roland VersaWorks.

Note on the setting in Roland VersaWorks

When you set the dry time in Roland VersaWorks, if [Use Printer Settings] is set, 0 is set to the dry time. You should note that the setting in the BN-20 driver is not reflected.

Resetting All Adjustments to Factory Default Values

Click "Factory Reset" in the "Option" tab of Utilities, and you can reset all the settings in utilities to the initial settings.

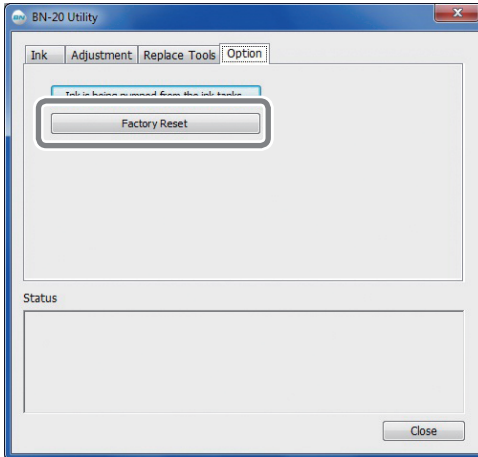

Click "FactoryReset", and the message shown in the figure is displayed. Click "Yes" to reset the settings.

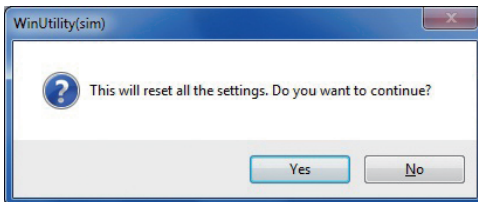

Chapter 3

Maintenance

Introduction: About Maintenance	68
Automatic Maintenance Function: Points to Note.....	68
Maintenance Schedule	68
Checking Ink Levels and Replacing	69
Checking Ink Levels	69
How to Replace Ink Cartridges.....	70
Daily Maintenance	71
Maintenance of Ink Cartridges.....	71
Cleaning	71
Replacing the Waste Cartridge.....	72
Care and Maintenance of the Print Heads	73
Periodical Cleaning Maintenance	74
About Periodical Cleaning Menus	74
Medium and Powerful Cleaning.....	74
Manual Head Cleaning	76
Replacing Consumable Parts	78
Replacing the Wiper	78
Replacing the Felt Wiper	79
Replacing the Cutter Blade.....	80
When Moving the Unit.....	82
Procedures from Preparing to Move Through Reinstalling.....	82

Introduction: About Maintenance

Automatic Maintenance Function: Points to Note

This machine has a function to automatically perform periodical maintenance tasks, e.g. to prevent the print heads from drying out. To ensure the maintenance is properly carried out, please observe the following points:

- **Make sure that the main power is on at all times.**
- **Never leave the front cover open for long periods.**

Maintenance Schedule

Carry out maintenance on a daily basis.

To keep this machine in tip-top condition, make sure that daily maintenance is actually performed every day.

☞ P. 71, "Daily Maintenance"

Some maintenance tasks need to be carried out periodically.

To maintain reliable output conditions, some maintenance tasks need to be carried out at least once a month.

☞ P. 74, "Periodical Cleaning Maintenance"

Switch the sub power on at least every 2 weeks

Switch the sub power on at least every 2 weeks. When the sub power is on, operations to prevent the print heads from drying out are automatically performed. If the machine is not used for a long period of time, print heads may be damaged. It is important to make sure to include this task in your maintenance schedule.

Maintain the temperature and humidity within the specified range

Even when the machine is not in use, maintain the temperature between 5 to 40°C (41 to 104 °F), with a relative humidity of 20 to 80%, with no condensation. Failure to keep the temperature and humidity within the specified range may cause a machine malfunction.

Checking Ink Levels and Replacing

Checking Ink Levels

Ink levels can be checked in the Ink tab of the Utility window. A simple bar scale indicates the level of ink in each cartridge.

* Displayed ink levels are estimates and are slightly different from the actual ink levels.

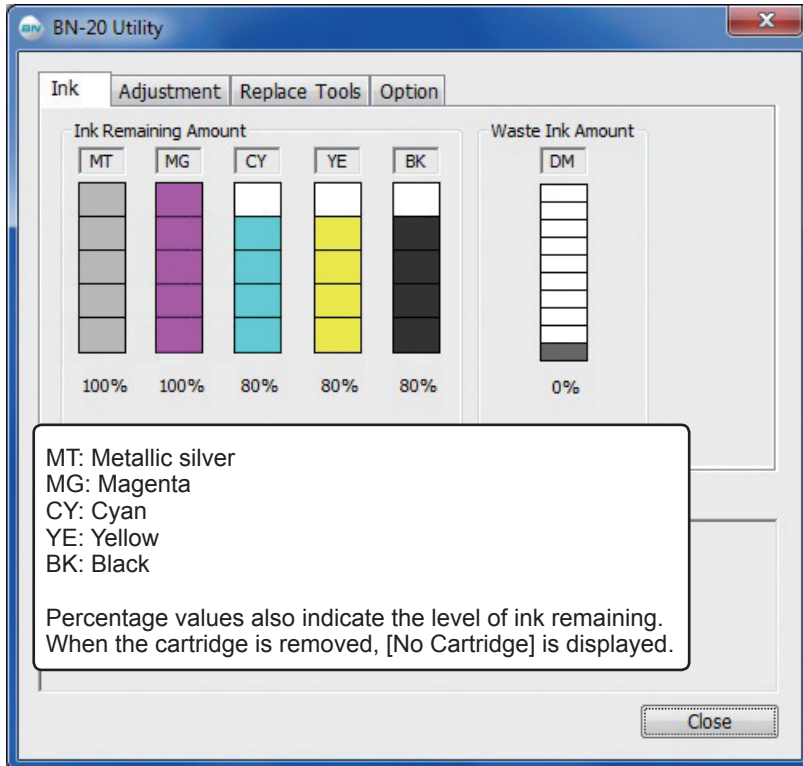

When an ink level is low, a message appears on the Utility icon on the task tray. Check the ink which is running out in Utilities and prepare a relevant cartridge for replacement.

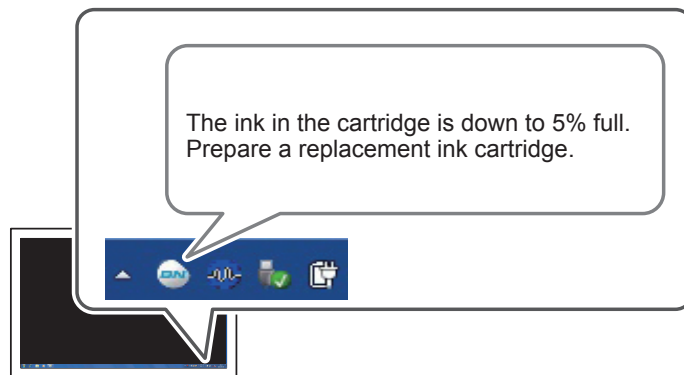

How to Replace Ink Cartridges

When ink runs out, a warning beep is heard and printing is temporarily suspended. Pull out the empty cartridge and insert a new one. Then printing resumes.

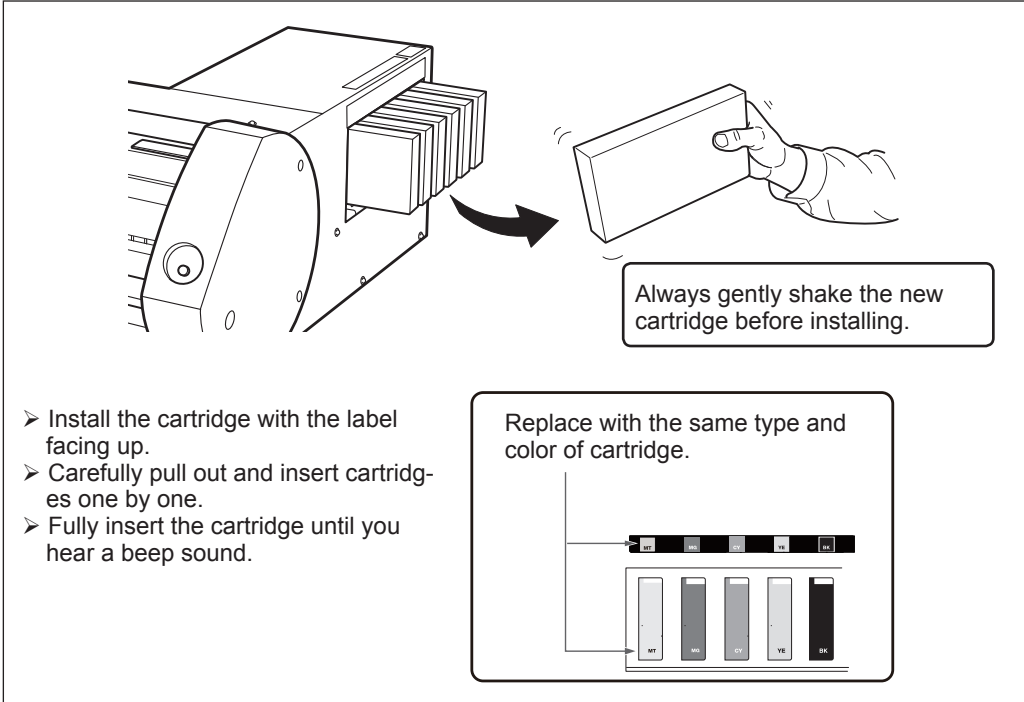

Always gently shake the new cartridge before installing.

- Install the cartridge with the label facing up.
- Carefully pull out and insert cartridges one by one.
- Fully insert the cartridge until you hear a beep sound.

Replace with the same type and color of cartridge.

IMPORTANT! Points to note when replacing cartridges

- Make sure to replace with the same type of cartridge.
- Never mix different types of cartridges.
- Never leave an ink cartridge slot empty. This may cause the print heads to clog up.
- Do not remove or insert a partially used ink cartridge without reason.
- Do not pull out an ink cartridge when the printer is in operation.

⚠WARNING

Never store ink, cleaning fluid or discharged fluid under the following conditions:

- Close to naked flames
- High temperatures
- Near bleach or other oxidizers, or explosives
- Keep out of the reach of children.

These chemicals are a fire risk. If children swallow these chemicals, they are toxic and a health hazard.

Daily Maintenance

Maintenance of Ink Cartridges

Ensure the following procedures are carried out without fail. The ink ingredients have a tendency to separate and settle. Metallic silver ink is particularly prone to separation; if left, such separated ingredients will dry and harden, and this may cause a malfunction.

- **Always gently shake a new cartridge before installing.**
- **Everyday before the start of operations, remove only the metallic silver ink cartridge, gently shake and reinstall.**

Cleaning

⚠ WARNING Never use gasoline, alcohol, thinner or any other inflammable substances.
All such substances are a fire risk.

Daily cleaning: wipe off any ink and grime on the media path. The pinch rollers, grit rollers, and platen are particularly subject to grime. Use neutral detergent diluted with water, and a damp cloth to wipe off ink and grime.

POINT!

- This machine is a precision device and is affected by dust and dirt. Clean thoroughly on a daily basis.
- Never oil or lubricate the machine.

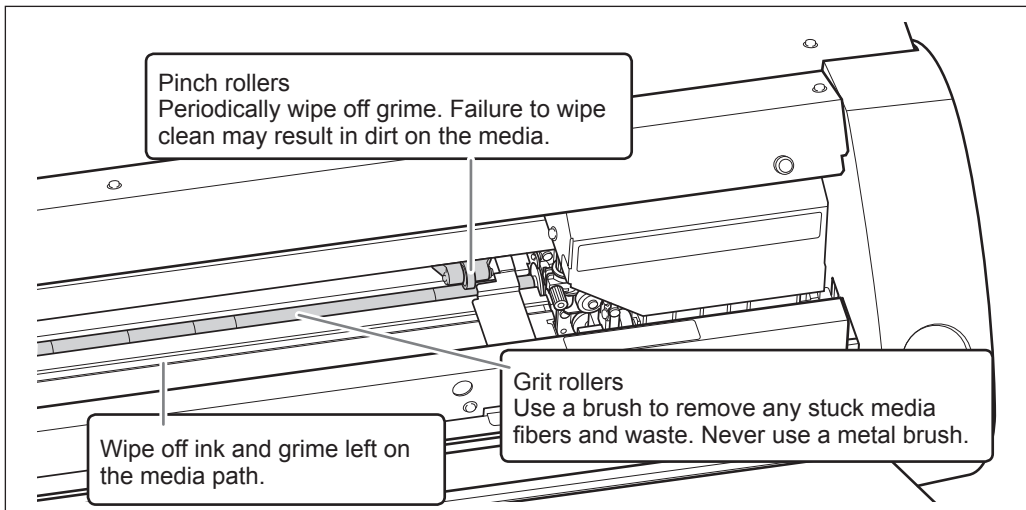

Replacing the Waste Cartridge

When the waste cartridge is filled with waste fluid, the Utility window automatically opens and displays a message in the Status column that prompts the replacement of the cartridge. Follow the message's instructions and prepare a replacement waste cartridge or replace the cartridge.

The waste cartridge is full.
Insert a new waste cartridge.
If you do not have a waste cartridge that you can replace the existing one with, turn the printer off.

⚠ CAUTION Remove the waste cartridge after the message appears in the Utility window. If this procedure is not followed, discharged fluid may overflow from the main unit and stain your hands or drip and stain the floor.

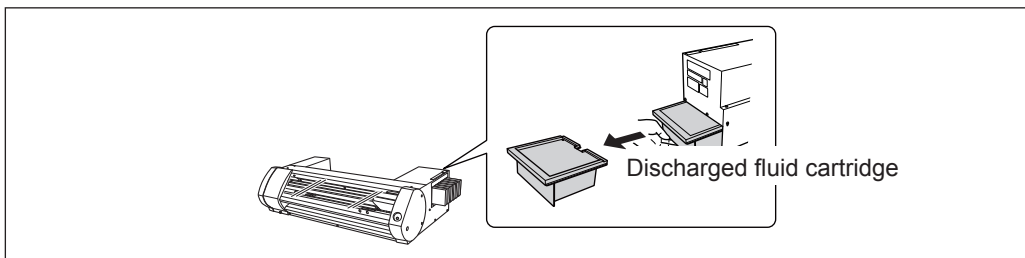

When you replace the cartridge, the following message is displayed. Take necessary action in accordance with the message.

Have you replaced the cartridge with a new one?
If you have, click Yes.
If you do not have a waste cartridge that you can replace the existing one with, turn the printer off.

To purchase a waste cartridge, contact your authorized dealer or Roland DG. Never use a used waste cartridge. The waste fluid may overflow because it cannot be managed properly.

⚠ WARNING Never place discharged fluid cartridge near open flame. These fluids are fire risks.

⚠ CAUTION Never open the cap of the waste cartridge. If the fluid is spilled or vapor escapes, this may be a fire risk, or the fumes may induce nausea.

Dispose of discharged fluid properly and in accordance with Health and Safety regulations. The discharged fluid is inflammable and contains toxic ingredients. Never burn or incinerate, or dispose of the discharged fluid with general waste. Do not empty the discharged fluid into a sewage system, stream or river. There is a risk of environmental impact.

Care and Maintenance of the Print Heads

To ensure optimum printing, the print heads need to be maintained in good condition. There are two kinds of maintenance: daily maintenance and periodical maintenance.

Daily care and maintenance

Normal Cleaning

We recommend performing Normal Cleaning everyday before the start of operations.

☞ P. 21, "STEP 3: Printing Tests and Normal Cleaning"

Periodical care and maintenance

☞ P. 74, "Periodical Cleaning Maintenance"

* Print heads are consumable parts and subject to wear. Depending on the frequency of use, periodical replacement is required. Please order them directly from us or your authorized Roland DG Corp. dealer.

Periodical Cleaning Maintenance

About Periodical Cleaning Menus

There are four levels of cleaning for this machine. Choose the appropriate menu in accordance with the machine condition and previous use.

Normal Cleaning	Carry out test printing before the start of daily operations; if dot drop-out occurs, perform Normal Cleaning. ⇨ P. 21, "STEP 3: Printing Tests and Normal Cleaning"
Medium Cleaning	If dot drop-out is not corrected by one level of cleaning, move to the next level, e.g. Normal Cleaning > Medium Cleaning > Powerful Cleaning. ⇨ P. 74, "Medium and Powerful Cleaning"
Powerful Cleaning	
Manual Head Cleaning	Perform Manual Head Cleaning in accordance with the frequency of use. To maintain reliable output conditions, perform Manual Head Cleaning at least once a month. ⇨ P. 76, "Manual Head Cleaning"

Medium and Powerful Cleaning

If dot drop-out is still found after Normal Cleaning, carry out the more powerful "Medium Cleaning" 2 or 3 times. If the condition is still not improved, carry out the even stronger "Powerful Cleaning."

POINT!

Each level of cleaning consumes more ink than the previous level. If these levels of cleaning are performed too often, the print heads are likely to wear out; do not over clean at any level.

Procedure

1 Open the Utility window.

⇨ P. 7, "How to Open the Utility Window / Exit the Utility"

2

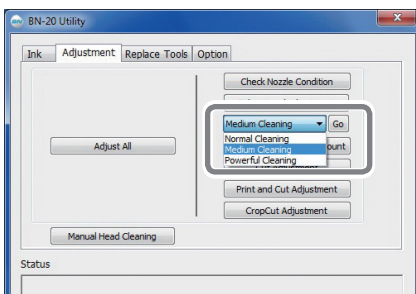

In the [Adjustment] tab, select [Medium Cleaning] and click [Go].

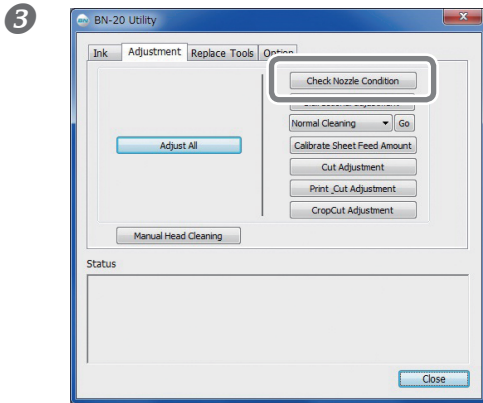

Click [Check Nozzle Condition].

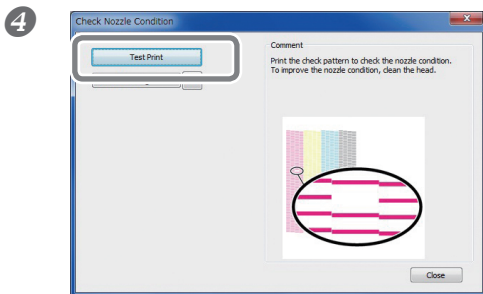

Click [Test Print].

The test pattern is printed. Follow the on-screen instructions to check for nozzle clogging.

Nozzle is clogged ⇒ Proceed to **5**.
 Nozzle is not clogged ⇒ Click [Finish] to finish.

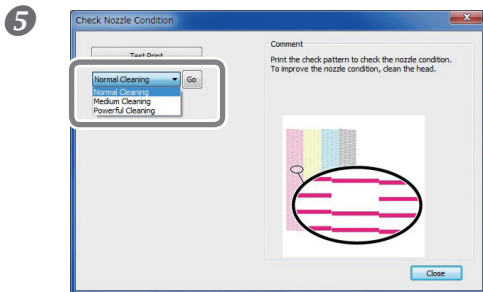

Select [Medium Cleaning] and click [Go].

Medium cleaning starts.

6 To check for nozzle clogging again ⇒ Return to **4**.

If the nozzle condition is not fixed by "Medium Cleaning", perform "Powerful Cleaning".

When Powerful Cleaning Is Not Effective

If after several times of Powerful Cleaning, nozzle clogging is still found, perform [Manual Head Cleaning]. It is most effective to periodically perform this level of cleaning in accordance with the frequency of use.

⇨ P. 76, "Manual Head Cleaning"

Manual Head Cleaning

How often is Manual Head Cleaning needed?

Perform Manual Head Cleaning at least once a month.



To maintain reliable output conditions, perform Manual Head Cleaning at least once a month.

If the following problems are found, Manual Head Cleaning is recommended

If the following problems occur and any of the automatic cleaning functions have not solved the problem, perform Manual Head Cleaning.

Please note that replacement of the wiper may also be an effective method to solve a problem.

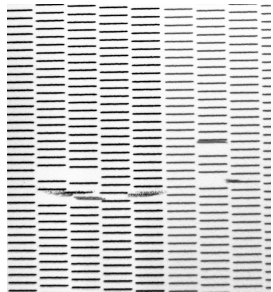
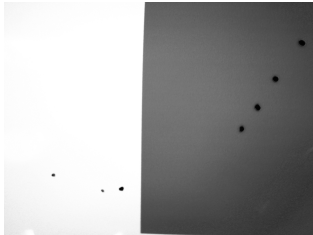
☞ P. 78, "Replacing the Wiper"

Nozzle clogging	Ink spots	Dragged dirt
		
<p>Dust and dirt stick to the print heads and prevent normal discharge of ink.</p>	<p>Ink gathers around dirt and grime near the print heads and ink drops are formed.</p>	<p>Dragging occurs when dirt around the print heads comes into contact with media.</p>

- When you need to order the cleaning sticks and cleaning fluid for Manual Head Cleaning, please contact us directly or your authorized Roland DG Corp. dealer.
- Print heads are consumable parts. Depending on the frequency of use, periodical replacement is required. Please order them directly from us or your authorized Roland DG Corp. dealer.

IMPORTANT!

Important requirements for Manual Head Cleaning

- Remove media before cleaning.
- To prevent the heads from drying out, complete the cleaning within 30 minutes. After 30 minutes a warning alarm will sound.
- Only use the included cleaning sticks. Any other tool, e.g. cotton bud or similar is not designed for this task and will become fluffy and damage the heads. Please order cleaning sticks directly from us or your authorized Roland DG Corp. dealer.
- Do not use a cleaning stick more than once; the print quality will deteriorate. Dispose of the stick after each cleaning.
- Do not soak a used cleaning stick in cleaning fluid; the cleaning fluid will deteriorate.
- Do not rub the nozzle surface of the head.
- Clean the sponge section by stroking very lightly and gently. Do not rub, scrape, or flatten the section.

When a warning alarm sounds during cleaning

An alarm sounds 30 minutes after the start of the operation. Perform the operation by following the message displayed in the Utility window.

CAUTION

Always carefully follow the procedures in accordance with the instructions.

Otherwise a sudden movement of the machine may cause injury.

Procedure

1 Open the Utility window.

☞ P. 7, "How to Open the Utility Window / Exit the Utility"

2

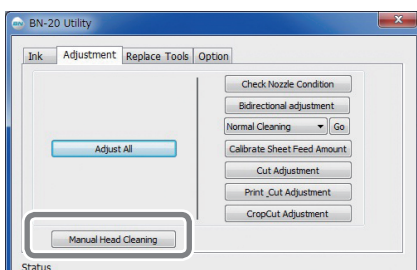

In the [Adjustment] tab, click [Manual Head Cleaning].

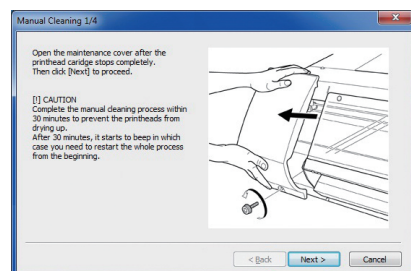

Manual Head Cleaning procedures are displayed. Carefully read the on-screen instructions and start the cleaning tasks.

3 Carry out test printing and check the result.

Use the cleaning functions and perform cleaning several times if needed.

☞ P. 21, "STEP 3: Printing Tests and Normal Cleaning"

Replacing Consumable Parts

Replacing the Wiper

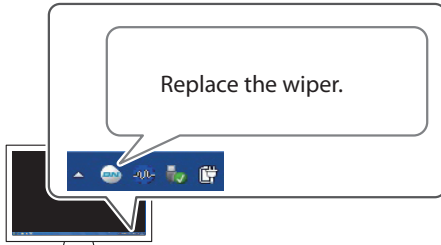

The wiper is a component used for cleaning the print heads. When the message shown in the figure appears on the Utility icon on the computer task tray, it is time to replace the wiper with a new one. To purchase a wiper, contact us directly or your authorized Roland DG Corp. dealer.

When the warning alarm sounds during replacing the wiper

An alarm sounds about 30 minutes after the start of the operation. Perform the operation by following the message displayed in the Utility window.



CAUTION Always carefully follow the procedures in accordance with the instructions. Otherwise a sudden movement of the machine may cause injury.

Procedure

1 Open the Utility window.

☞ P. 7, "How to Open the Utility Window / Exit the Utility"

2

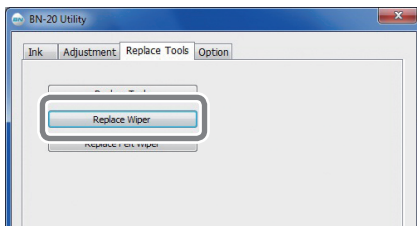

In the [Replace Tools] tab, click [Replace Wiper].

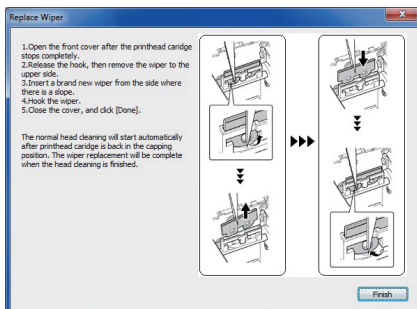

Procedures for replacing the wiper are displayed. Carefully read the on-screen instructions and start the replacement work.

3 When the operation is completed, close the front cover.

Replacing the Felt Wiper

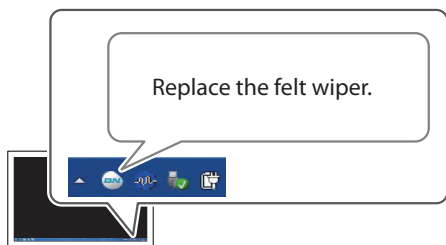

The felt wiper is a component used for cleaning the print heads. When the message shown in the figure appears on the Utility icon on the computer task tray, it is time to replace the wiper with a new one. To purchase a felt wiper, contact us directly or your authorized Roland DG Corp. dealer.

When the warning alarm sounds during replacing the felt wiper

An alarm sounds about 30 minutes after the start of the operation. Perform the operation by following the message displayed in the Utility window.

CAUTION

Always carefully follow the procedures in accordance with the instructions.

Otherwise a sudden movement of the machine may cause injury.

Procedure

1 Open the Utility window.

☞ P. 7, "How to Open the Utility Window / Exit the Utility"

2

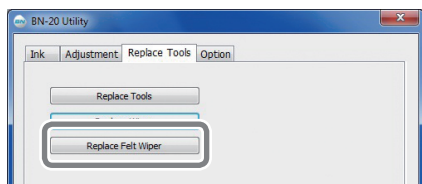

In the [Replace Tools] tab, click [Replace Felt Wiper].

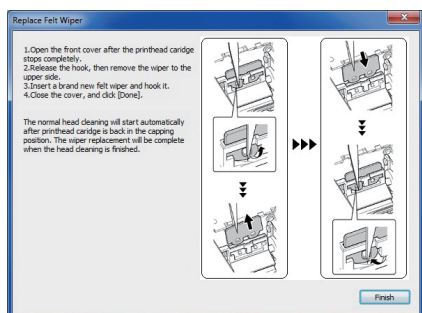

Procedures for replacing the felt wiper are displayed. Carefully read the on-screen instructions and start the replacement work.

3 When the operation is completed, close the front cover.

Replacing the Cutter Blade

When the cutter blade is blunt, the edge is chipped, or the cutting quality has deteriorated, replace with a new cutter blade.

⚠ CAUTION

Always carefully follow the procedures in accordance with the instructions.

Otherwise a sudden movement of the machine may cause injury.

⚠ CAUTION

Never touch the edge of the blade.

Doing so may result in injury.

Procedure

1 Open the Utility window.

☞ P. 7, "How to Open the Utility Window / Exit the Utility"

2

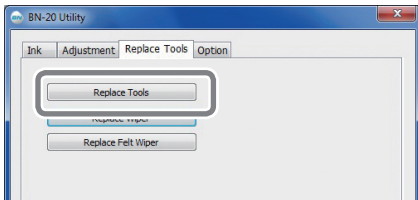

In the [Replace Tools] tab, click [Replace Tools].

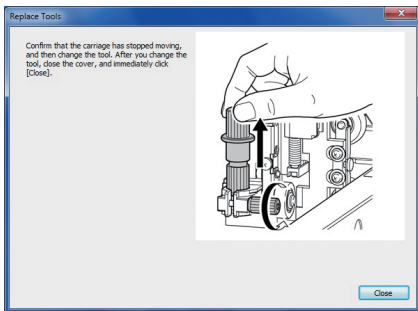

If the screen shown in the figure appears, open the front cover and replace the blade.

3

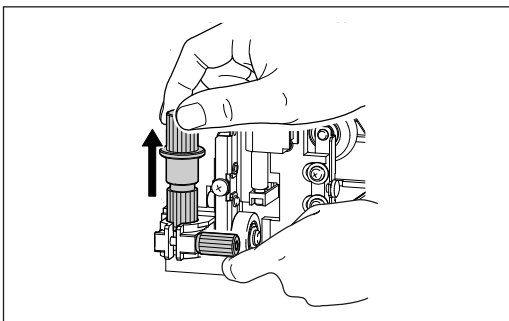

Remove the blade holder.

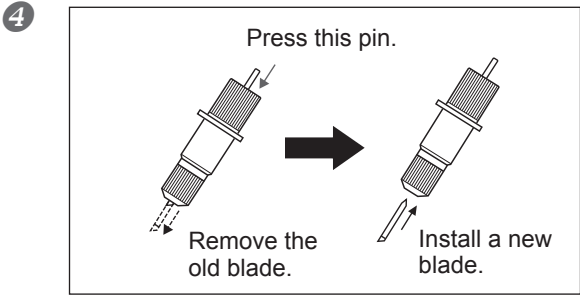

Replace the blade.

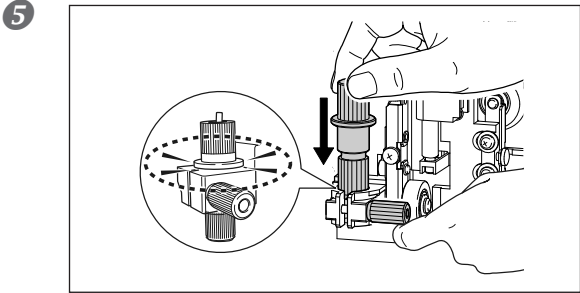

Support the screw from below and insert the blade holder.

Failure to do this may adversely affect the cutting quality.

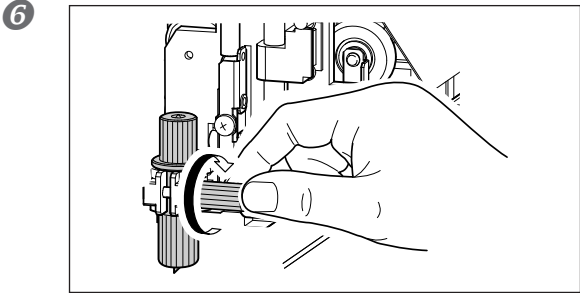

Firmly tighten the screw.

Tug the blade holder upward to make sure it does not come loose.

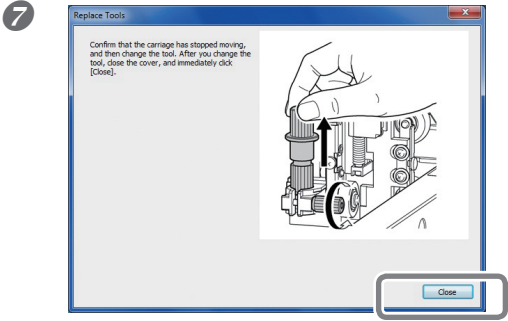

Close the front cover.

Click [Close].

Replacement is now completed.

8 Make adjustments for cutting.

P. 28, "Adjusting Cutting"

When Moving the Unit

Procedures from Preparing to Move Through Reinstalling

To move the machine, you must completely drain all ink inside the machine and secure the print heads in place with packing materials to protect them. Attempting to move the machine without first doing this may result in damage to internal components due to leaking ink or damage to the heads.

Important Notes on Moving

- Once the preparations for moving are complete, move the machine and fill it with ink with as little delay as possible. Allowing the machine to stand without ink may damage the print heads.
- When moving the machine, keep it at a temperature between 5 to 40°C (41 to 104°F) and at relative humidity between 20 to 80% (with no condensation). Failure to do so may result in breakdown.
- Handle the machine with care when moving, keeping it level (not tilted at an angle) and preventing it from striking other objects.

Procedure

1 Open the Utility window.

☞ P. 7, "How to Open the Utility Window / Exit the Utility"

2

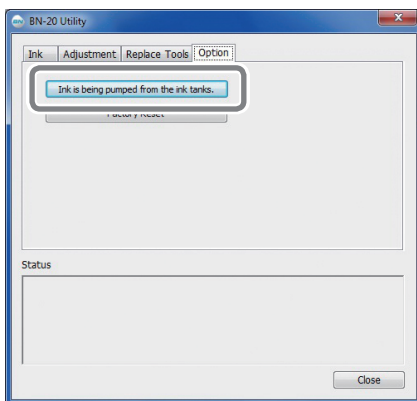

In the [Option] tab, click [Ink is being pumped from the ink tanks].

Carry forward the work by following the instructions displayed on the screen.

3 Move as soon as possible.

4 Immediately reinstall the machine and fill with ink.

See "First Step Guide" and promptly fill with ink.

Chapter 4

Appendix

Read this section whenever you face a problem	84
The Machine Doesn't Run	84
Attractive Printing or Cutting is Impossible	85
Media Jam Occurs!.....	87
Media Feed is Not Smooth	87
Print Head Stops Moving.....	88
Installation is impossible.....	89
When uninstalling the driver, perform following operation.....	91
Important Notes When Performing Output from General Application ...	93
Important Notes When Performing Output from Adobe Illustrator.....	93
Important Notes When Performing Output from CoreIDRAW ...	93
Handling Messages and Error Messages	94
A Message Appears.....	94
An Error Message Appears	95
Main Specifications	98
Maximum Area.....	98
Maximum Area When Using Crop Marks	98
About the Blade	99
Locations of the Power Rating and Serial Number Labels.....	99
Dimensional Drawing.....	100
Specifications	101
System Requirements for USB Connection	103

Read this section whenever you face a problem

The Machine Doesn't Run

The Printer Unit Doesn't Run

Is the power switched on?

Switch on the printer's main power, then press the POWER key and make sure the key lights up.

Does the POWER key stay steadily lighted?

Output is not performed when POWER key does not stay steadily lighted. After the media is loaded, pull the loading lever.

Is the POWER key flashing?

When the POWER key flashes, no operation except for canceling output is accepted.

Is the cover open?

Close front cover, and maintenance cover.

Has ink run out?

If you send the output data in a state where there is no ink left, a warning buzzer will sound and the machine will stop temporarily. A message indicating that ink has run out is displayed in the Status field of Utilities. When the ink cartridge is replaced with a new one, printing or cutting starts.

⇨ P. 70, "How to Replace Ink Cartridges," p. 95, "An Error Message Appears"

Is a message displayed on the Utility icon in the task tray or in the Utility window?

⇨ P. 94, "A Message Appears," p. 95, "An Error Message Appears"

Is the cable connected?

Connect the cable securely.

⇨ "First Step Guide"

Is the driver installed correctly?

If the connection to the computer is not made in the sequence described, the driver may fail to be installed correctly. The Utility does not function normally when driver is misconfigured. Check again to ensure that the connection was made using the correct procedure.

⇨ "First Step Guide"

Are two or more machines connected to a single computer?

The utility cannot control more than one machine at the same time. Never connect two or more instances of this machine to a single computer.

Is the temperature of the room too low?

This machine does not complete startup until the heater reaches the specified temperature, and does not accept any operation. When the ambient temperature is low, the heater is slow to warm up. Use the machine in an environment where the temperature is 20 to 32° C (68 to 90° F).

Did you forcibly remove any detachable external storage device connected by USB?

When you remove the USB removable device (USB flash drive or USB hard disk etc.), you must run [Safely Remove Hardware and Eject Media] or [Eject] before detaching it. If you remove the USB device without it in process of printing, the printing may be aborted.

Attractive Printing or Cutting is Impossible

Printed results are coarse or contain horizontal stripes

Do the print heads show nozzle clogging?

Carry out a printing test and make sure no nozzle clogging occurs. If nozzle clogging is present, perform head cleaning.

☞ P. 21, "STEP3 : Printing Tests and Normal Claeaning," p. 74, "Medium and Powerful Cleaning," p. 76, "Manual Head Cleaning"

Have you carried out "Calibrate Sheet Feeding Amount"?

Large misalignment in the amount of feed of the media may result in printing that seems coarse or contains horizontal stripes. We recommend performing "Calibrate Sheet Feeding Amount" before daily operations and when changing the media type.

☞ P. 22, "STEP 4: Calibrate Sheet Feeding Amount"

Have you carried out "Bidirectional adjustment"?

We recommend performing "Bidirectional adjustment" before daily operations and when changing the media type. The optimal adjustment value may vary, depending mainly on the thickness of the media.

☞ P. 19, "STEP 2: Bidirectional Adjustment"

Is the temperature of the room too low?

The heater may not warm up sufficiently when the ambient temperature is less than 20°C (68°F). Also, even when the heater warms up, an adequate effect may not be obtained if the media is thoroughly chilled. Before printing, allow the media to come to room temperature.

Is the printer installed in a level and stable location?

Never install the machine in a location where it is tilted or where it may wobble or experience vibration. Also make sure that the print heads are not exposed to moving air.

Is the printer installed in a location out of direct sunlight?

Never install in a location exposed to direct sunlight.

Is the media loaded and set up correctly?

If the media is not loaded and set up correctly, printing may be adversely affected. Make sure the media is loaded and set up correctly.

☞ P. 87, "Media Feed is Not Smooth"

Colors are unstable or uneven

Did you shake the ink cartridges gently before in-stalling them?

Shake new cartridges gently before you install them.

When the metallic silver ink is used, gently shake the metallic silver ink cartridge before daily operations.

☞ P. 40, "Characteristics of Metallic Silver Ink and Important Notes"

Is the media wrinkled?

If the media is wrinkled and comes loose from the platen, colors may be uneven or printing quality may suffer.

☞ P. 87, "Media Feed is Not Smooth"

Is the printer installed in a level and stable location?

Never install the machine in a location where it is tilted or where it may wobble or experience vibration. Also, make sure that the print heads are not exposed to circulating air. These factors may lead to nozzle clogging or reduced printing quality.

Is the printer being used in a location subject to severe changes in the operating environment?

Large fluctuations in temperature or humidity while printing is in progress may cause the colors to change partway through. When you're performing printing, use the machine in a location where temperature and humidity are stable.

The media becomes soiled when printed

Is the print head dirty?

The following may cause ink to drip on the media during printing.

- Buildup of fibrous dust (lint) around the heads.
- Ink transferred to the heads due to rubbing against the media.

If this happens, perform manual head cleaning. We recommend carrying out periodic print head cleaning.

☞ P. 74, "Periodical Cleaning Maintenance"

- Too Low Humidity.

Use this machine in the environment of 35 to 80 %RH (non condensation).

Cutting is misaligned or skewed

Is the media loaded and set up correctly?

If the media is not loaded and set up correctly, or media feed is not smooth, cutting may be adversely affected. Make sure the media is loaded and set up correctly.

☞ P. 87, "Media Feed is Not Smooth"

Are the settings for the cutting conditions appropriate?

Misalignment or skewing may occur if the cutting speed is too fast or the blade force is too high. Try changing the cutting conditions. With media having a strong adhesive layer, the adhesive layer reattaches to itself immediately after cutting. However, if a cutting test shows that the peeling of the media and the blade traces on the backing paper are optimal, then the media is being cut properly. Be careful not to make the blade force too high.

☞ P. 28, "Adjusting Cutting," p. 30, "Accurately Adjusting the Cutting-in Amount," and p. 30, "Rough Estimate for the Amount of Blade Extension"

Is the length of output too long?

For printing & cutting in particular, the longer the page length (that is, the longer the distance the media is returned after printing), the greater is the chance of misalignment occurring. It is a good idea to keep the size of each single page to the minimum necessary.

Are you using media that exhibits large expansion and contraction?

When you're performing printing & cutting, misalignment occurs if the media expands or contracts. If this happens, try performing printing with crop marks, then setting the base point and one or more align points and performing cutting. This corrects for expansion and contraction of the media.

☞ P. 35, "Performing Printing and Cutting Separately"

The printed surface is damaged when cutting

Does the tip of the blade holder cap scrape the printed surface?

The tip of the blade holder cap may scrape, and soil or damage the printed surface. If this happens, increase the amount of blade extension.

☞ P. 30, "Accurately Adjusting the Cutting-in Amount"

Media Jam Occurs!

The Media Jams

If an error message is displayed because the media has jammed, immediately correct the problem. Failure to do so may damage the print head.

☞ P. 95, "An Error Message Appears"

Is the media warped or wrinkled?

Many factors can cause warping or wrinkling. Refer to the following and correct the problem.

☞ P. 87, "Media Feed is Not Smooth"

Media Feed is Not Smooth

A variety of problems can occur if the media feed is not smooth. This can cause such problems as poor printing quality, contact with the media by the print head, misaligned positioning, or media jams. Take action as follows.

Media Wrinkles or Shrinks

Is the media loaded and set up straight and securely?

Feed is not smooth when the media is not straight or is tensioned unevenly on the left and right. Reload the media.

☞ P. 14, "STEP 1: Loading Media"

Was loaded media allowed to stand for some time?

Media may shrink or wrinkle if it is heated for an extended time. When printing ends, press and hold down the POWER key to switch off the sub power or remove the media.

Was the media loaded while the heater was hot?

Loading media after the heater has warmed up causes the temperature of the media to rise suddenly, which may cause the media to shrink or wrinkle during printing. Before loading media, switch off the sub power and allow the platen to cool.

Is the temperature of room too low?

Use this machine in an environment having an ambient temperature of 20 to 32°C (68 to 90°F). If the machine is used at an ambient temperature less than 20°C, then depending on the type or width of the media, wrinkling or temperature-caused unevenness may occur. To obtain stable printing results, the machine should be used at an ambient temperature of 20 to 32°C(68 to 90°F).

Is the humidity of the room too high?

Use this machine in the environment of 35 to 80 %RH (non condensation).

Is the using media deflected?

If using the deflected media, it cause winkle of the media.

Media Feed Is Not Straight

Is the media loaded and set up straight and securely?

Feed is not smooth when the media is not straight or is tensioned unevenly on the left and right. Reload the media.

☞ P. 14, "STEP 1: Loading Media"

Media Feed Is Not Smooth

Do the media strike some other object?

Make sure the media do not touch anything else. This may affect output, even when feed appears to be smoothly.

☞ P. 14, "STEP 1: Loading Media"

Is the media too thick?

Media that is too thick may not only cause unstable feed, but may scrape the print head, resulting in malfunction. Never use such media.

Are the grit rollers dirty?

Check to make sure the grit rollers are free of buildup of foreign material such as media scraps.

☞ P. 71, "Cleaning"

Print Head Stops Moving.

If the print-head carriage stops over the platen, take action immediately to prevent the heads from drying out.¹

What to Do First

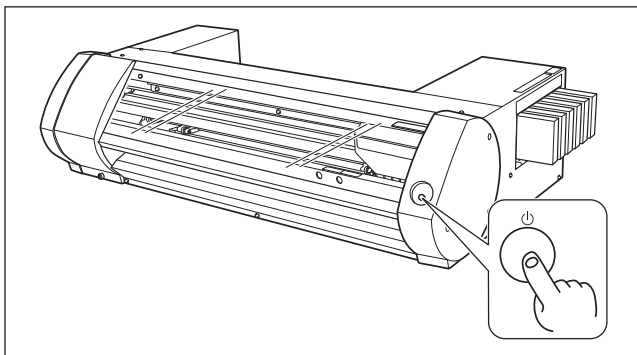

Hold down the POWER key for one second or longer to switch the sub power off, then back on.

If the media is jammed, then also remove the media.

If the print-head carriage move to the standby position (on the right side of the machine), it means the operation has ended successfully.

If The Heads Still Do Not Move

Try switching off the main power, then again switching on the main power, followed by the sub power.

If the print-head carriage move to the standby

If the heads still do not move after "What to Do First" is performed, carry out the following emergency response measure, then contact your authorized Roland DG Corp. dealer.

Procedure

1

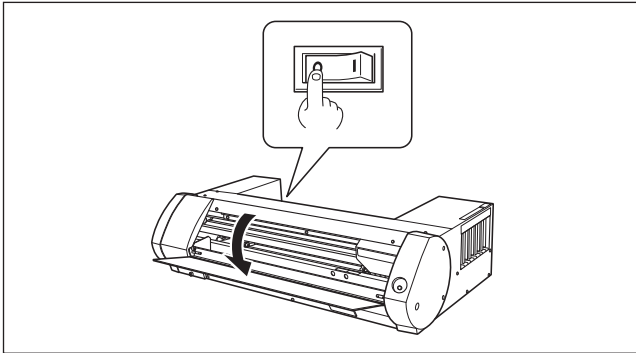

Switch off the main power and open the front cover.

2

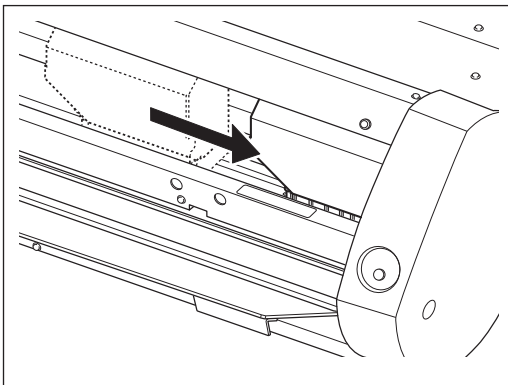

Gently move the print head to the standby position.

Stopping at the place where the audible click is heard locks the print head in place.

3

Gently apply pressure from the right side to make sure the heads don't move to the left.

If the print head moves to the left, again move them slowly by applying pressure from the left side and make sure they lock in place.

Installation is impossible

If installation quits partway through, or if the wizard does not appear when you make the connection with a USB cable, take action as follows.

Windows 7

1. If the [Found New Hardware] appears, click [Cancel] to close it.
2. Click the [Start] menu, then right-click [Computer]. Click [Properties].
3. Click [Device Manager]. The [User Account Control] appears, click [Continue]. The [Device Manager] appears.
4. At the [View] menu, click [Show hidden devices].

5. In the list, find [Other devices], then double-click it. When the model name you are using or [Unknown device] appears below the item you selected, click it to choose it.
6. Go to the [Action] menu, and click [Uninstall].
7. In "Confirm Device Uninstall" window, select [Delete the driver software for this device.], and then click [OK]. Close the [Device Manager].
8. Disconnect the USB cable from the computer, and then restart Windows.
9. Uninstall the driver. Carry out the steps from step 3 in page 91 "Uninstall the Driver Windows 7" to uninstall the driver.
10. Install the driver again according to "BN-20 First Step Guide."

Windows Vista

1. If the [Found New Hardware] appears, click [Cancel] to close it.
2. Click the [Start] menu, then right-click [Computer]. Click [Properties].
3. Click [Device Manager]. The [User Account Control] appears, click [Continue]. The [Device Manager] appears.
4. At the [View] menu, click [Show hidden devices].
5. In the list, find [Printers] or [Other device], then double-click it. When the model name you are using or [Unknown device] appears below the item you selected, click it to choose it.
6. Go to the [Action] menu, and click [Uninstall].
7. In "Confirm Device Uninstall" window, select [Delete the driver software for this device.], and then click [OK]. Close the [Device Manager].
8. Disconnect the USB cable from the computer, and then restart Windows.
9. Uninstall the driver. Carry out the steps from step 3 in page 91 "Uninstall the Driver Windows Vista" to uninstall the driver.
10. Install the driver again according to "BN-20 First Step Guide."

Windows XP

1. If the [Found New Hardware Wizard] appears, click [Finish] to close it.
2. Click the [Start] menu, then right-click [My Computer]. Click [Properties].
3. Click the [Hardware] tab, then click [Device Manager]. The [Device Manager] appears.
4. At the [View] menu, click [Show hidden devices].
5. In the list, find [Printers] or [Other device], then double-click it. When the model name you are using or [Unknown device] appears below the item you selected, click it to choose it.
6. Go to the [Action] menu, and click [Uninstall].
7. In "Confirm Device Uninstall" window, click [OK].
8. Close the [Device Manager] and click [OK].
9. Detach the USB cable from the computer, and then restart Windows.
10. Uninstall the driver. Carry out the steps from step 3 in page 92 "Uninstall the Driver Windows XP" to uninstall the driver.
11. Install the driver again according to "BN-20 First Step Guide."

When uninstalling the driver, perform following operation.

Windows 7

*If the driver is uninstalled without following the procedure given below, there is a possibility that it might not be able to be re-installed.

1. Before you start uninstallation of the driver, unplug the USB cables from your computer.
2. Log on to Windows as "Administrator" right.
3. From the [Start] menu, click [Control Panel]. Click [Uninstall a program].
4. Click the driver for the machine to delete to select it, then Click [Uninstall].
5. A message prompting you to confirm deletion appears. Click [Yes].
6. From the [Start] menu, choose [All Programs], then [Accessories], then [Run], and then click [Browse].
7. Choose the name of the drive or folder where the driver is located. (*)
8. Select "SETUP.EXE" and click [Open], then click [OK].
9. The [User Account Control] appears, click [Allow].
10. The Setup program for the driver starts.
11. Click [Uninstall] to choose it. Select the machine to delete, then click [Start].
12. If it is necessary to restart your computer, a window prompting you to restart it appears. Click [Yes].
13. The uninstallation finishes after the computer restarts.

(*)

When using the CD-ROM, specify the folder as shown below (assuming your CD-ROM drive is the D drive).

D:\Drivers\25D\WIN7X64 (64 bit edition)

D:\Drivers\25D\WIN7X86 (32 bit edition)

Windows Vista

1. Before you start uninstallation of the driver, unplug the USB cables from your computer.
2. Log on to Windows as "Administrators" right.
3. From the [Start] menu, click [Control Panel]. From the [Hardware and Sound] group, click [Printer]. [Printer] folder opens.
4. Click the model name's icon you are using. From the [Organize] menu, click [Delete]. The [User Account Control] appears, click [Continue].
5. A message prompting you to confirm deletion appears. Click [Yes].
6. In the [Printers] folder, right-click any location where no printer icon is present. From the [Run as administrator] menu, select [Server Properties]. The [User Account Control] appears, click [Continue].
7. Click the [Drivers] tab, then from the [Installed printer drivers] list, choose the machine to delete. Click [Remove].
8. The [Remove Driver And Package] appears, select [Remove driver and driver package]. Click [OK].
9. When the prompt message appears, click [Yes].
10. The package and driver to delete are displayed. Make sure that what is displayed is the machine you want to delete, then click [Delete].
11. The items that have been deleted are displayed. Click [OK].
12. Click [Close] on [Remove Driver And Package] window.
13. From the [Start] menu, choose [All Programs], then [Accessories], then [Run], and then click [Browse].
14. Choose the name of the drive or folder where the driver is located. (*)
15. Select "SETUP.EXE" and click [Open], then click [OK].
16. The [User Account Control] appears, click [Allow].
17. The Setup program for the driver starts.
18. Click [Uninstall] to choose it. Select the machine to delete, then click [Start].

19. If it is necessary to restart your computer, a window prompting you to restart it appears. Click [Yes].
20. The uninstallation finishes after the computer restarts.

(*)

When using the CD-ROM, specify the folder as shown below (assuming your CD-ROM drive is the D drive).

D:\Drivers\25D\WINVISTAX64 (64 bit edition)

D:\Drivers\25D\WINVISTAX86 (32 bit edition)

Windows XP

1. Before you start uninstallation of the driver, unplug the USB cables from your computer.
2. Log on to Windows as "Administrators" right.
3. From the [Start] menu, click [Control Panel]. Click [Printers and Other Hardware], then click [Printers and Faxes].
4. Click the model name's icon you are using. From the [File] menu, choose [Delete].
5. A message prompting you to confirm deletion appears. Click [Yes].
6. Go to [File] and select [Server Properties].
7. Click the [Driver] tab, then from the [Installed printer drivers] list, choose the machine to delete.
8. Click [Delete]. When the prompt message appears, click [Yes].
9. From the [Start] menu, select [Run], then click [Browse].
10. From the [File Locations] list, choose the name of the drive or folder where the driver is located. (*)
11. Select "SETUP.EXE" and click [Open], then click [OK].
12. The Setup program for the driver starts.
13. Click [Uninstall] to choose it. Select the machine to delete, then click [Start].
14. If it is necessary to restart your computer, a window prompting you to restart it appears. Click [Yes].
15. The uninstallation finishes after the computer restarts.

(*)

When using the CD-ROM, specify the folder as shown below (assuming your CD-ROM drive is the D drive).

D:\Drivers\25D\WINXPX64 (64 bit edition)

D:\Drivers\25D\WINXPX86 (32 bit edition)

Important Notes When Performing Output from General Application

Important Notes When Performing Output from Adobe Illustrator

These are cautionary notes on making output from Adobe Illustrator and CorelDRAW using the BN-20 driver. They are not applied when Roland VersaWorks is used.

Illustrator CS5, CS4, and CS3: You cannot print rectangles with metallic line or fill colors.

“Rectangles” refers to shapes that meet all the following conditions.

- Four anchor points
- Four 90-degree angles
- Rotation angle of 0, 90, 180, or 270 degrees

* These conditions may also apply to the uppercase “I” and lowercase “L” characters.

To avoid this problem, select the rectangle, and then click the [Object] menu, [Path], and then [Add Anchor Points]. You can add anchor points to a rectangle without changing the rectangle's shape. For text, first make the text into an outline, and then add anchor points by following the above procedure.

When you want to print in metallic color and when you want to perform cutting, clear the [Print As Bitmap] checkbox in the [Print] dialog box.

To display the [Print] dialog box, click [Print] on the [File] menu.

Set the document's color mode to [RGB].

If you select CMYK mode, the CMYK values will be converted to RGB values when the output is generated. In this situation, the RGB colors that you used the driver to specify as metallic colors and cutting lines will differ from the RGB colors that are generated by Illustrator, so you will not be able to print metallic colors or perform cuts.

Please don't cancel printing by operating Illustrator.

If you cancel printing, press the BN-20 power key for a few seconds. When you print from Illustrator to BN-20, the now printing message is displayed. If you click [Cancel] button in the message box, but the printing process is still alive. You cannot operate the Illustrator until the end of printing process.

Important Notes When Performing Output from CorelDRAW

Set the document's color mode to [RGB].

If you select CMYK mode, the CMYK values will be converted to RGB values when the output is generated. In this situation, the colors that you used the driver to specify as metallic colors and cutting lines will differ from the colors that are generated by CorelDRAW, so you will not be able to print metallic colors or perform cuts.

Handling Messages and Error Messages

A Message Appears

These are the main messages that appear in the Utility window to prompt correct operation. They do not indicate any error. There are other messages that appear in the Utility window. Follow the displayed prompts and take action accordingly.

[XX ink : Shake the cartridge well]

Remove the ink cartridge that is indicated in *** and shake it well. In particular, always shake the metallic silver ink once at the start of daily operations.

☞ P. 40, "Characteristics of Metallic Silver Ink and Important Notes," p. 71, "Maintenance of Ink Cartridges"

[The Waste cartridge is full.]

The waste cartridge is full. Replace the waste cartridge with a new one.

☞ P. 72, "Replacing the Waste Cartridge"

[Replace the wiper]

It is time to replace the wipers. Replace the wipers.

☞ P. 78, "Replacing the Wiper"

[Replace the felt wiper]

It is time to replace the felt wiper. Replace the felt wiper.

☞ P. 79, "Replacing the Felt Wiper"

[The connection to the printer has been released.]

A USB cable that connects this machine and the computer is unplugged, or the main power of this machine is switched off. If the machine is allowed to stand with the main power switched off, the automatic maintenance fails to work and it may cause a machine malfunction. Make sure that the main power is on at all times.

An Error Message Appears

This topic describes some of the error messages that may appear in the Utility window, and how to take action to remedy the problem. In addition to the messages described below, the Utility window shows the causes of errors and troubleshooting information. If the troubleshooting information displayed in the Utility window or action described here does not correct the problem, or if an error message not described here appears, contact your authorized Roland DG Corp. dealer.

[The pinch roller position is incorrect.]

[The media size is not acceptable for this machine, and thus the position of the pinch roller is not correct.]

If the pinch roller position is incorrect, the media cannot be secured properly. Specific media sizes can be positioned properly with the pinch roller on this machine.

☞ P. 10, "Size" in "Usable Media"

[Crop marks could not be printed. Output will be canceled.]

The size of the data including the crop marks is larger than the printing or cutting area of the loaded media.

Make the printing or cutting area wider, such as by replacing the media with a larger piece of media or by changing the positions of the pinch rollers, then send the data again.

☞ P. 35, "Media Sizes Allowing Automatic Crop Mark Detection"

The size of the data being output is too small.

Set the size of the data in the new scanning value (direction in which the print heads move) to at least 65 mm (2.6 in.). Change the size of the data, then send the data again. There is no limitation in the size of the data in the new feeding direction.

[Crop mark detection could not be started./Crop marks were not found. Output will be canceled.]

[Automatic detection of crop marks could not be accomplished.]

Load the media at the correct position and perform detection of crop marks again. If repeating automatic crop-mark detection results in an error again, then change the type of media. Depending on the media, it may not be possible to detect crop marks automatically.

☞ P. 35, "Performing Printing and Cutting Separately"

[The operation has been stopped to prevent the head from drying out. Turn the printer off.]

The print head was forced to standby position to prevent them from drying out.

Operation cannot be continued. Switch the sub power off, then back on. Opening the front cover while printing is in progress causes an emergency stop. Never allow the print heads to remain in this state.

[Motor error]

A motor error occurred.

Operation cannot be continued. By following the messages displayed in the Utility window, remove the media, close the front cover, and then hold down the POWER key to switch the sub power off. This error may be caused by such factors as an incorrect loading of the media, a media jam, or an operation that pulls the media with excessive force. Eliminate the cause of the error before switching the sub power on, and then reload the media.

[Waste cartridge is estimated to be full]

Output is stopped because the waste cartridge is full

Output cannot be resumed without correcting this error. Replace the waste cartridge with a new one by following the message displayed in the Utility window. If a new waste cartridge is not available for immediate replacement, switch the main power off.

[Temperature error]

The temperature of the location where the machine is installed has risen above or fallen below the ambient temperature at which the machine can operate.

Operation cannot be continued. Switch off the sub power. Bring the installed location to a temperature at which operation is possible (20 to 32°C) and allow the machine to come to room temperature, then turn on the power.

[Cover open error.]

Output is stopped because the front cover or the maintenance cover is open.

Start output again after closing the cover.

[Sheet setup error]

Setup of the media has failed. Load the media correctly.

☞ P. 14, "STEP 1: Loading Media"

[Data error]

Output was stopped because a problem was found in the data received.

Operation cannot be continued. Check for errors in the data. Check for a problem with the connector cable or the computer, and start output again.

[Ink has run out.]

Output is stopped because ink has run out.

In the [Ink] tab of the Utility window, check the color of the cartridge that has run out of ink, and replace the ink cartridge with a new one.

☞ P. 69, "Checking Ink Levels," p. 70, "How to Replace Ink Cartridges"

[Pinch lever was returned.]

Output is stopped because the loading lever is pushed backward while output is in progress.

Pushing the loading lever backward cancels the setup of the media, so output is stopped. Reload the media.

[No sheet is present.]

Output is attempted but it fails because no media is present

Set up the media.

Printing cannot continue because the end of the sheet was detected. Printing will be canceled.

Printing is stopped because the trailing edge of the media is detected

When the trailing edge of the media is detected, output is cancelled. Load new media.

[ServiceCall No]**

An unrecoverable error occurred, or part replacement that must be performed by a service technician is required.

Note the number displayed on the screen, then switch off the main power. After you switch off the power, inform your authorized Roland DG Corp. dealer of the number that appeared on the screen.

[Ink Cartridge error : * ink cartridge]**

A cartridge that cannot be used was installed.

Remove the ink cartridge of the indicated color to clear the error. Use an ink cartridge of the specified type. ("***" is the color of the ink)

[BN-20 Utility is already running.]

You try to start BN-20 utility though it is already running.

Utility is resident software that remains active even when it is hidden from the screen. When it is hidden from the screen, it is located in the task tray in the lower right corner of the computer screen.

☞ P. 7, "How to Open the Utility Window / Exit the Utility"

[The cleaning fluid cartridge is empty. Replace the cleaning fluid cartridge with a new one.]

Operation is stopped because the cleaning fluid cartridge is empty

This message appears when operations such as "Pump Ink" are in progress. Operation cannot be resumed without correcting this error. Replace with a new cleaning fluid cartridge immediately. If the machine is allowed to stand with the empty cartridge, it may result in a malfunction.

Main Specifications

Maximum Area

The printing or cutting area along the horizontal plane (the direction in which the carriages move) is determined by the position of the pinch rollers.

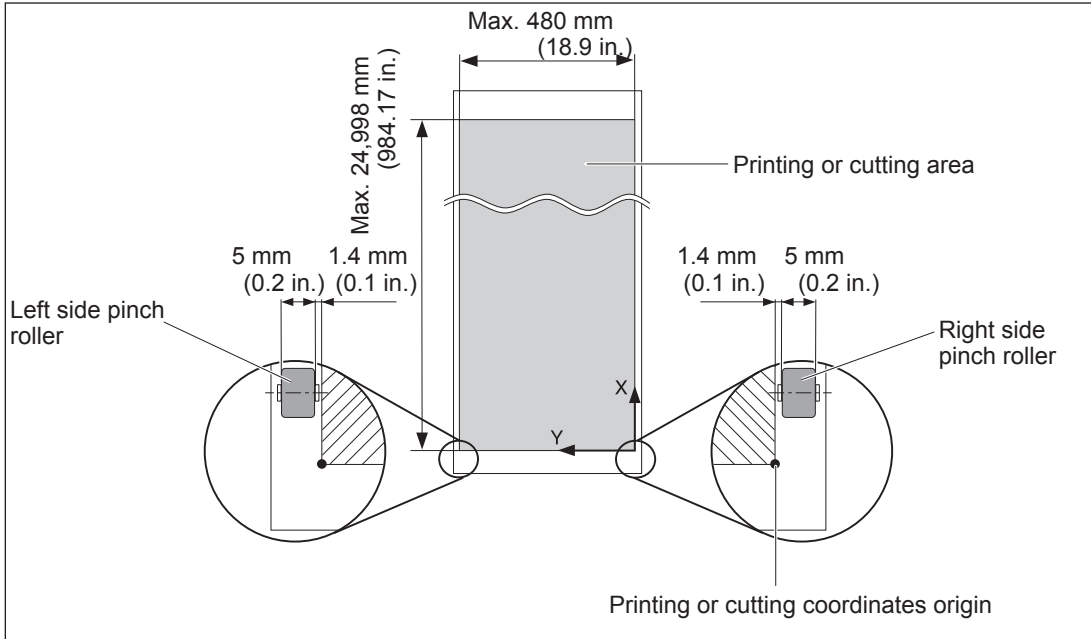

Maximum Area When Using Crop Marks

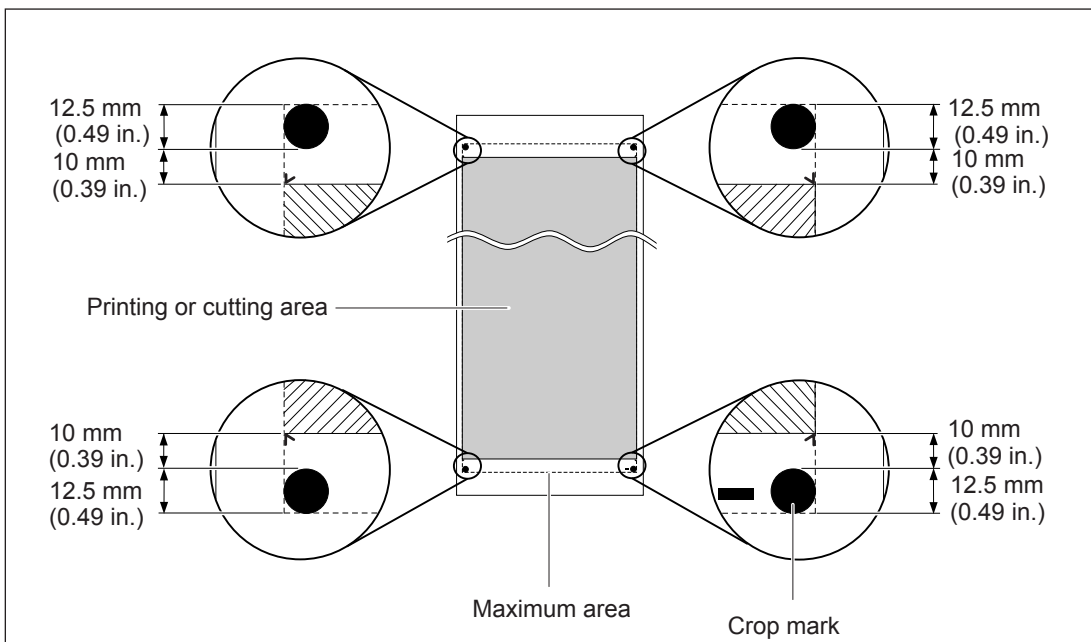

About the Blade

The cutting conditions and the service life of the blade change according to the media and the operating environment, even when you're using identical blades. The service life also differs according to the type of blade. A rough guide is shown below.

Blade	Media	Blade force	Amount of blade offset	Blade life* (general guide)
ZEC-U1005	General signage vinyl	50 to 150 gf	0.25 mm	8000 m
ZEC-U5025	General signage vinyl	30 to 100 gf	0.25 mm	4000 m
	Fluorescent vinyl	120 to 200 gf	0.25 mm	4000 m
	Reflective vinyl	100 to 200 gf	0.25 mm	4000 m

When uncut areas remain even when the blade force is increased to a value that is higher by 50 to 60 gf than the values shown in this chart, then replace the blade.

*The values for "Blade life" are estimates for when an identical type of media is used.

Locations of the Power Rating and Serial Number Labels

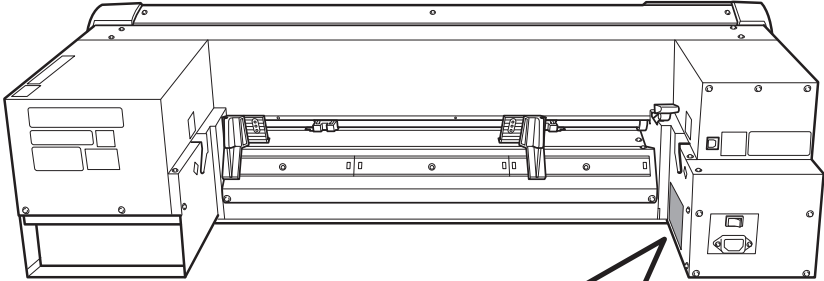

Serial Number
This is required when you seek maintenance, servicing, or support. Never peel off the label or let it get dirty.

Power Rating
Use an electrical outlet that meets the requirements for voltage, frequency, and amperage given here.

Dimensional Drawing

Unit: mm

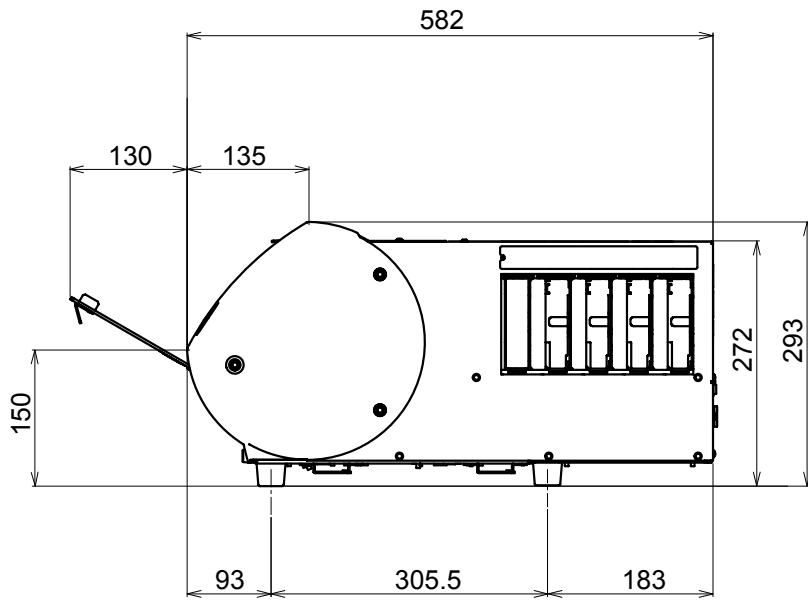
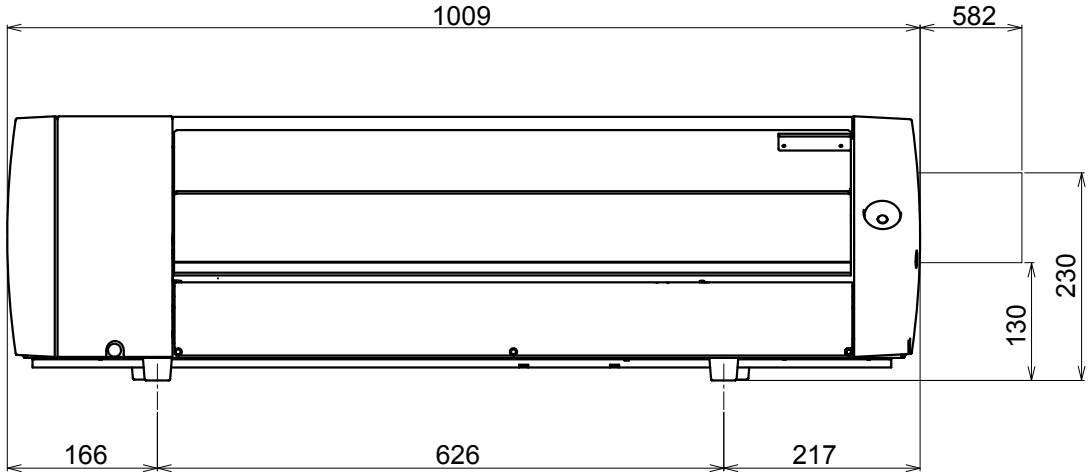

Specifications

		BN-20
Printing technology		Piezoelectric inkjet
Media	Width(*1)	150 to 515 mm (5.9 to 20.3 in.)
	Thickness	Maximum 1.0 mm (39 mil) with liner, for printing Maximum 0.4 mm (16 mil) with liner and 0.22 mm (9 mil) without liner, for cutting
	Roll outer diameter	Maximum 150 mm (5.9 in.)
	Roll weight	Maximum 6 kg (13.2 lb.)
	Core diameter	76.2 mm (3 in.) or 50.8 mm (2 in.)
Printing/cutting width (*2)		Maximum 480 mm (18.9 in.)
Ink cartridges	Types	ECO-SOL MAX: 220-cc cartridge AQUEOUS PIGMENT ink (FPG) 220-cc cartridge
	Colors	Five colors (cyan, magenta, yellow, black, metallic silver) Four colors (cyan, magenta, yellow, and black) (Five colors is only ECO-SOL MAX)
Printing resolution (dots per inch)		Maximum 1,440 dpi
Cutting blade	Type	Roland CAMM-1 series compatible
	Blade offset	0.25 mm (9 mil)
Cutting speed		1 to 15 cm/s
Blade force		30 to 300 gf
Software resolution (when cutting)		0.025 mm/step
Distance accuracy (when printing) (*3) (*4)		Error of less than $\pm 0.3\%$ of distance traveled, or ± 0.3 mm, whichever is greater
Distance accuracy (when cutting) (*3) (*5)		Error of less than $\pm 0.4\%$ of distance traveled, or ± 0.3 mm, whichever is greater
Repeatability (when cutting) (*3) (*6)		± 0.1 mm or less
Alignment accuracy for printing and cutting (*3) (*7)		± 0.5 mm or less
Alignment accuracy for printing and cutting when reloading media (*3) (*8)		Error of less than $\pm 0.5\%$ of distance traveled, or ± 3 mm, whichever is greater
Print heater (*9)		Temperature: 35°C (95 °F) (fixed)
Connectivity		USB (compliant with Universal Serial Bus Specification Revision 2.0)
Power-saving function		Automatic sleep feature
Power requirements		AC 100 to 240 V $\pm 10\%$, 1.0 A, 50 / 60 Hz
Power consumption	During operation	Approx. 90 W
	Sleep mode	Approx. 5.5 W
Acoustic noise level	During operation	62 dB (A) or less
	During standby	42 dB (A) or less
Dimensions		1009 (W) x 582 (D) x 293 (H) mm (39.7 (W) x 22.9 (D) x 11.5 (H) in.)
Weigh		36 kg (79.4 lb.)
Installation Environment	Power on (*10)	Temperature: 20 to 32°C (68 to 90 °F), humidity: 35 to 80%RH (non-condensing)
	Power off	Temperature: 5 to 40°C (41 to 104°F), humidity: 20 to 80%RH (non-condensing)
Accessories		Power cord, USB cable, blade, blade holder, Roland Software Package, Software RIP (Roland VersaWorks), User's Manual, etc.

Main Specifications

(*1)

It must be within the ranges shown below:

- 150 to 170 mm (5.9 to 6.7 inch)
- 200 to 235 mm (7.9 to 9.3 inch)
- 287 to 322 mm (11.3 to 12.7 inch)
- 348 to 383 mm (13.7 to 15.1 inch)
- 393 to 429 mm (15.5 to 16.9 inch)
- 439 to 474 mm (17.3 to 18.7 inch)
- 487 to 515 mm (19.2 to 20.3 inch)

(*2)

The length of printing or cutting is subject to the limitations of the program.

(*3)

- Media type: Media specified by Roland DG Corp.
- Temperature: 25°C (77°F), humidity: 50%
- Roll media must be loaded correctly.
- Front margin: 35 mm or more
- Excluding expansion/contraction of the media
- All correction or adjustment function of this machine has been made properly.

(*4)

With Roland PET film, print travel: 1 m

(*5)

Range for assured repetition accuracy: Length 1,000 mm

(*6)

Range for assured repetition accuracy : Length 1,000 mm

(*7)

- Provided that media length is under 1,000 mm
- Excludes the effects of slanted movement and of expansion and contraction of the media.

(*8)

- Data size : 1,000 mm in the media-feed direction, 480 mm in the carriage-movement direction
- No lamination
- Automatic detection of crop marks at 4 points when media is reloaded.
- Excluding possible shift caused by expansion/contraction of the media and/or by reloading the media.

(*9)

Warm-up is required after power up. This may require 5 to 20 minutes, depending on the operating environment.

- Depending on the ambient temperature and media width, the temperature may fail to be reached 35 (°F).

(*10)

Operating environment

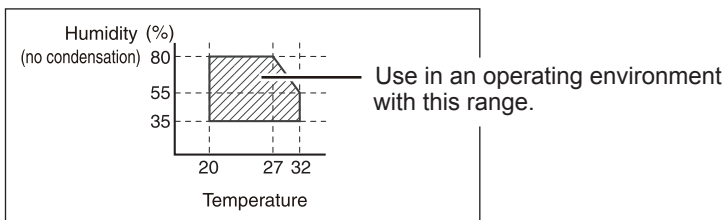

System Requirements for USB Connection

Computer	Model preinstalled with the 32- or 64-bit edition of Windows 7, Vista, XP, or upgraded computer originally preinstalled with Windows XP or later.
USB cable	Use the included USB cable.

 **Roland**



100008953

R2-110905